

Features

- 24-inch minimum base cabinet width.
- Single bowl.
- 9-inch depth.
- No faucet holes.

Material

- KOHLER® enameled cast iron.

Installation

- Under-mount

Recommended Products/Accessories

- K-8801 Sink Strainer
- K-8799 Sink Strainer



ADA

Codes/Standards















ASME A112.19.1/CSA B45.2
ADA
ICC/ANSI A117.1

KOHLER® Enameled Cast Iron Kitchen Sink Lifetime Limited Warranty

See website for detailed warranty information.

Available Colors/Finishes

Color tiles intended for reference only.

Color	Code	Description
	0	White
	FF	Sea Salt™
	96	Biscuit
	47	Almond
	FD	Cane Sugar™
	NY	Dune
	95	Ice™ Grey
	G9	Sandbar
	33	Mexican Sand™
	K4	Cashmere
	FT	Basalt
	58	Thunder™ Grey
	20	Suede
	KA	Black 'n Tan
	FP	Caviar

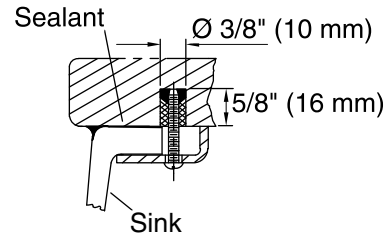
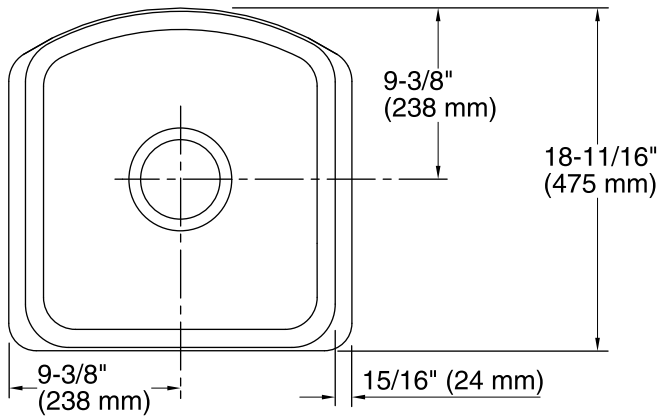

**Solid-Surface
Installation**

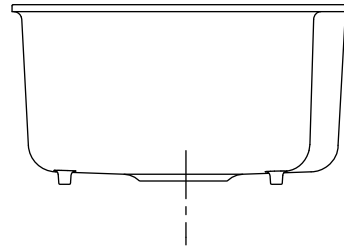
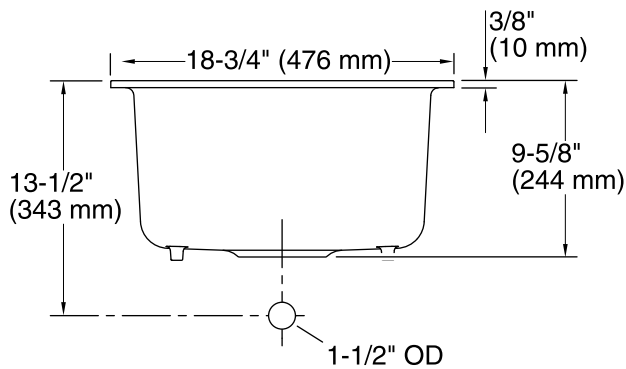

Technical Information

All product dimensions are nominal.

Installation:	Under-mount
Bowl area:	Length: 15-11/16" (399 mm) Width: 17-1/8" (435 mm) Bowl depth: 9" (229 mm) Water depth: 9" (229 mm)
Template:	1259678-7, required, included

Notes

Install this product according to the installation instructions.

ADA compliant when installed to the specific requirements of these regulations.