

Features

- Left-hand trip lever.
- Premium metal construction for durability.
- KOHLER finishes resist corrosion and tarnish.
- For use with the Memoirs Comfort Height toilet.
- Coordinates with other products in the Memoirs Collection.



ADA

Codes/Standards









ASME A112.18.1/CSA B125.1
ADA
ICC/ANSI A117.1

KOHLER® One-Year Limited Warranty

See website for detailed warranty information.

Available Color/Finishes

Color tiles intended for reference only.

Color	Code	Description
	SN	Vibrant® Polished Nickel
	AF	Vibrant® French Gold
	PB	Vibrant® Polished Brass
	G	Brushed Chrome
	BN	Vibrant® Brushed Nickel
	BV	Vibrant® Brushed Bronze
	2BZ	Oil-Rubbed Bronze
	BL	Matte Black
	RGD	Vibrant Rose Gold
	VNT	Vintage Nickel

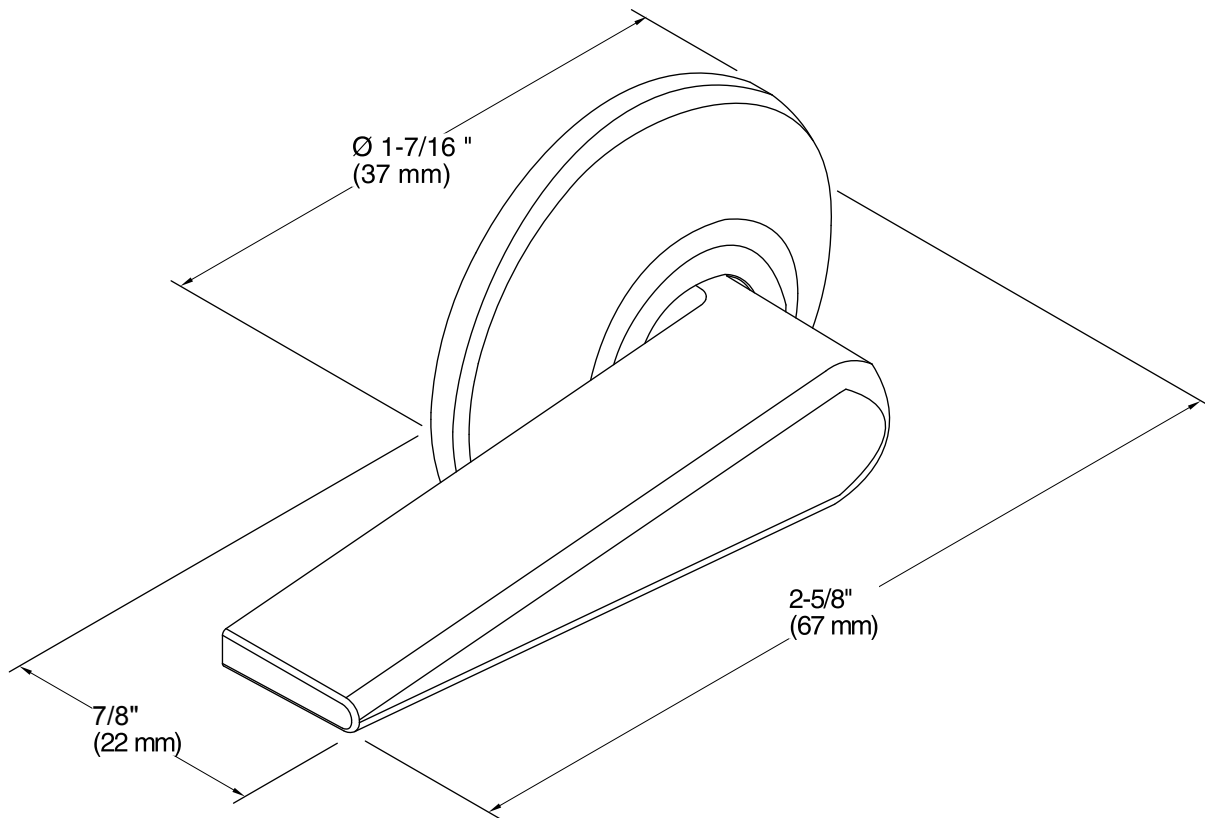

Technical Information

All product dimensions are nominal.

Notes

ADA compliant when installed to the specific requirements of these regulations.