

Features

- Finishes resist moisture, scratches, and stains
- One door and two drawers
- Three-way adjustable slow-close door hinges for easy cabinet access
- Soft-close, full extension, under-mount drawer slides for smooth opening
- Includes decorative cabinet hardware
- Industry-standard sizing coordinates with Ceramic/Impressions®, Iron/Impressions™, or Solid/Expressions™ tops (sold separately)
- Coordinates with other products in the Tresham collection

Material

- Solid wood and veneers

Required Products/Accessories

- K-20000 20-1/2" rectangular undermount bathroom sink
- K-27933 Drawer appliance organizer
- K-28250 Silestone® 37" quartz vanity top with rectangular cutout
- K-28263 Silestone® quartz 37" backsplash
- K-33585 Drawer organizer set
- K-33586 Drawer organizer with lid
- K-33588 Makeup display tray and organizer
- K-5446 Bathroom Vanity Top - Back Splash
- K-5451 Bathroom Vanity Top - Side Splash



Codes/Standards

EPA TSCA Title VI/CARB P2

KOHLER® One-Year Limited Warranty

See website for detailed warranty information.

Available Colors/Finishes

Color tiles intended for reference only.

Color	Code	Description
	1WA	Linen White
	F69	Woodland
	1WT	Mohair Grey

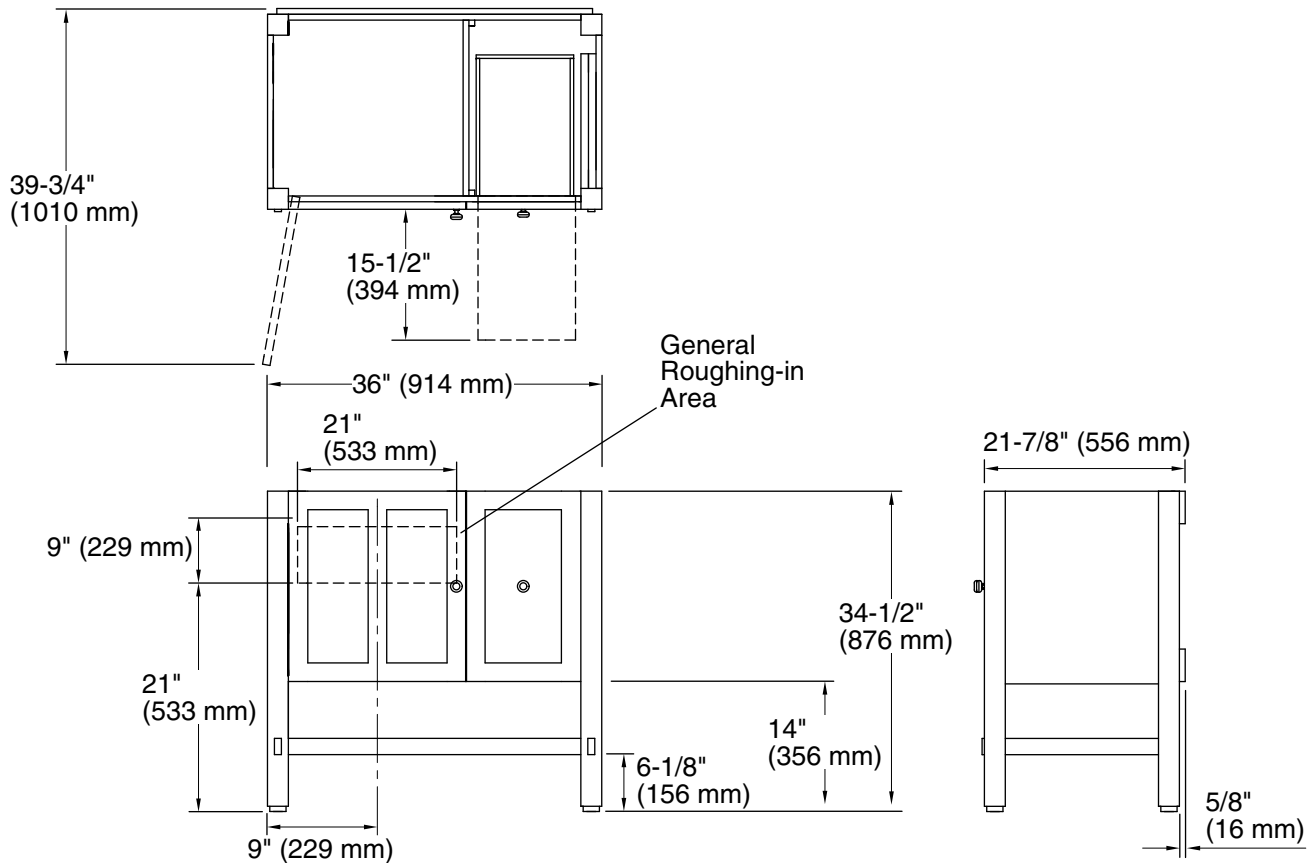

Technical Information

All product dimensions are nominal.

Vanity type: Standard

Notes

Install this product according to the installation guide.

The finished wall must be straight and plumb to ensure proper support of the vanity and alignment of the sink and door.

To properly support the weight of the vanity and sink, secure to stud framing or 2x6 bracing behind the finished wall.

Select 250 lb (113.4 kg) load bearing 5/16" lag bolts with a length to clear obstacles in the wall and 5/16" washers.