



Disposal Flange with Stopper K-11352

Features

- Fits standard garbage disposal units (4½" diameter, 1#" depth).
- Includes Disposal Flange and Stopper.
- Fits standard garbage disposal units (4½" diameter, 1#" depth).

Material

- Premium metal construction for durability and reliability.

Recommended Products/Accessories

K-23723 Faucet cleaner



Codes/Standards









None Applicable

KOHLER® One-Year Limited Warranty

See website for detailed warranty information.

Available Colors/Finishes

Color tiles intended for reference only.

| Color | Code | Description |
|---|------|--------------------------------|
|  | CP | Polished Chrome |
|  | SN | Vibrant® Polished Nickel |
|  | PB | Vibrant® Polished Brass |
|  | BN | Vibrant® Brushed Nickel |
|  | BS | Brushed Stainless |
|  | BV | Vibrant® Brushed Bronze |
|  | 2BZ | Oil-Rubbed Bronze |
|  | BL | Matte Black |
|  | 2MB | Vibrant® Brushed Moderne Brass |

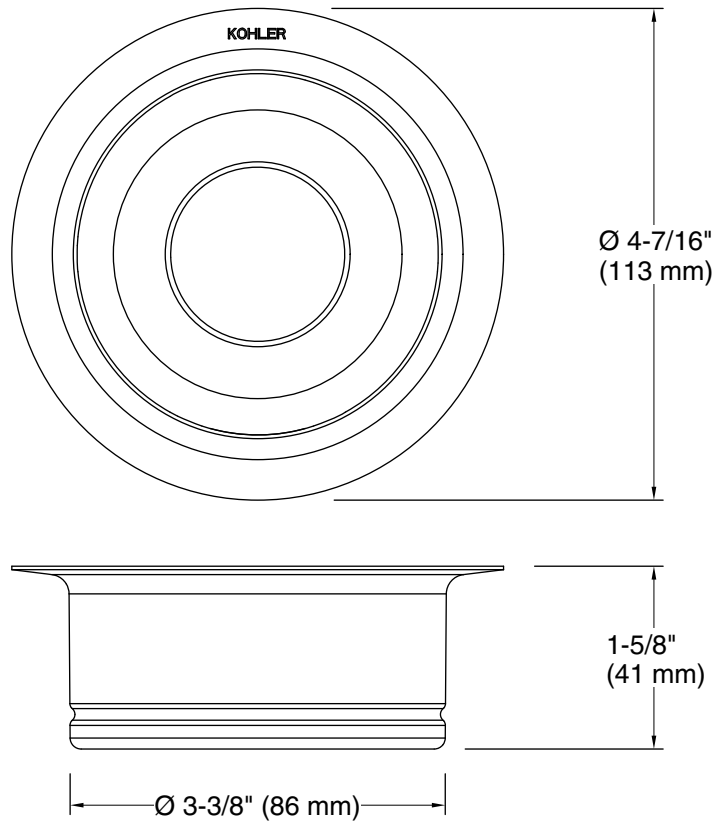

Technical Information

All product dimensions are nominal.

Material: Metal