

Features

- A single handle controls both on/off activation and temperature setting
- 9-1/8" (232 mm) high-arc spout
- 8.0 gpm (30.3 lpm) maximum bath faucet flow rate at 45 psi (3.1 bar)
- Includes Shift+® Round 1.75 gpm handshower and 60" hose
- 1.75 gpm (6.6 lpm) maximum handshower flow rate at 80 psi (5.5 bar)
- KOHLER ceramic disc valves exceed industry longevity standards for a lifetime of durable performance
- Part of the Occasion bathroom faucet and accessory collection

Material

- Premium metal construction for durability and reliability
- KOHLER finishes resist corrosion and tarnishing

Installation

- Floor-mount

Required Products/Accessories

For freestanding installation
K-97339 Mounting block for select floor-mount bath fillers

Recommended Products/Accessories

K-23723 Faucet cleaner
K-27060 18" towel bar
K-27061 24" towel bar
K-27062 24" double towel bar
K-27063 Towel ring
K-27064 Vertical toilet paper holder
K-27065 Pivoting toilet paper holder
K-27069 Robe hook
K-27128 Toilet paper holder with tray

Included Components

Additional Components:
21335-G



Codes/Standards







ASME A112.18.1/CSA B125.1
DOE - Energy Policy Act 1992
EPA WaterSense®
California Energy Commission (CEC)

KOHLER® Faucet Lifetime Limited Warranty

See website for detailed warranty information.

Available Colors/Finishes

Color tiles intended for reference only.

| Color | Code | Description |
|---|------|--------------------------------|
|  | CP | Polished Chrome |
|  | SN | Vibrant® Polished Nickel |
|  | BN | Vibrant® Brushed Nickel |
|  | BL | Matte Black |
|  | 2MB | Vibrant® Brushed Moderne Brass |
|  | BMB | Matte Black with Moderne Brass |

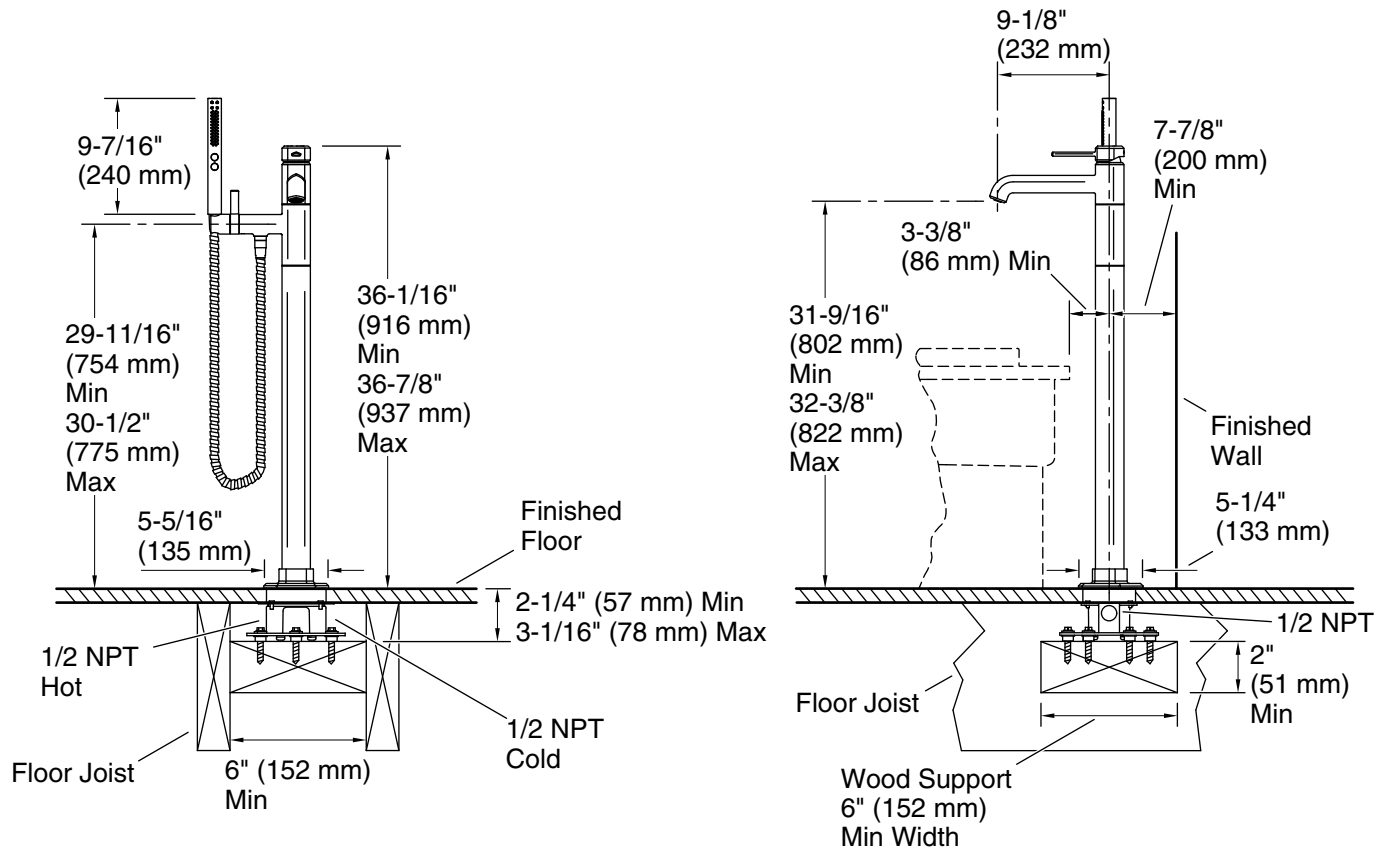

Technical Information

All product dimensions are nominal.

Shower Valve:

| | |
|-------------------------------|-------------------|
| Pressure: | 45 psi (3.1 bar) |
| Maximum (Static) Pressure: | 125 psi (8.6 bar) |
| Minimum (Operating) Pressure: | 20 psi (1.4 bar) |
| Drain included: | No |