

Features

- Trim plate includes temperature control knob with integrated adjustable high-temperature limit stop and shower outlet on/off buttons
- When pressed once, shower outlet turns on and button pops out, becoming a knob for water flow adjustment
- When pressed back in, water turns off and outlet button aligns with control plate surface; flow setting remains intact
- High-temperature limit setting for added safety
- Low-profile design with easy-to-clean water-resistant casing
- Requires three-port thermostatic valve with integral volume control (sold separately)
- Handles up to 8 gpm (30.3 lpm) flow capacity (rate may vary by installation)



Installation

- Mounts on finished wall surface

Required Products/Accessories

P34724-00 Mechanical showering three-port thermostatic valve with integrated volume control

Codes/Standards









ASME A112.18.1/CSA B125.1

KALLISTA® Five-Year Limited Warranty

See website for detailed warranty information.

Available Colors/Finishes

Color tiles intended for reference only.

Color	Code	Description
	CP	Polished Chrome
	BL	Matte Black
	AF	French Gold
	BAF	Brushed French Gold
	BN	Brushed Nickel
	BV	Brushed Bronze
	PB	Polished Brass
	SN	Polished Nickel

KALLISTA

Foundations by KALLISTA Mechanical showering three-outlet thermostatic control panel P34720-00

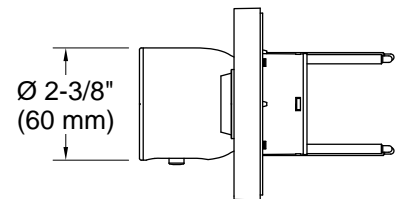
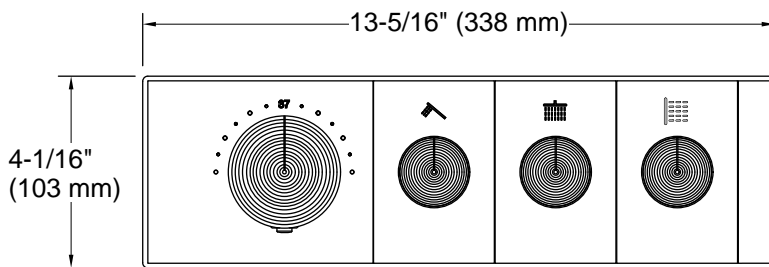
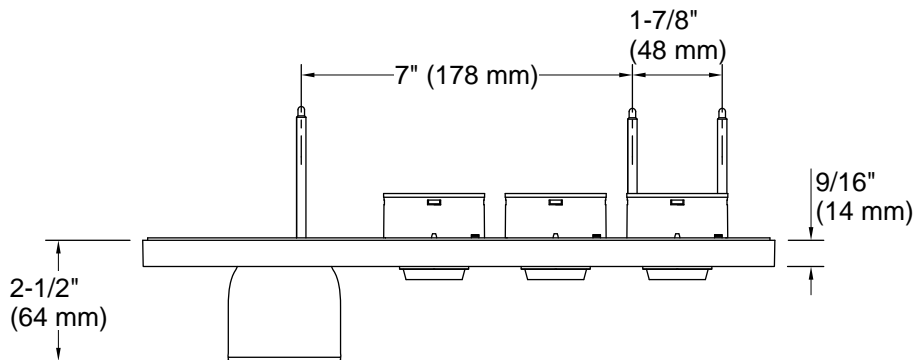

Technical Information

All product dimensions are nominal.

Notes

Install this product according to the installation instructions.