

Features

- Metal construction
- Reversible 1/2" quarter-turn washerless ceramic disc valves
- Lever or acrylic handles

Codes/Standards Applicable

Specified model meets or exceeds the following:

- ASME A112.18.1/CSA B125.1

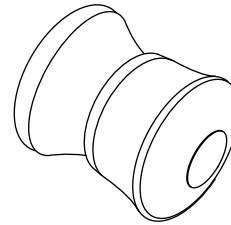
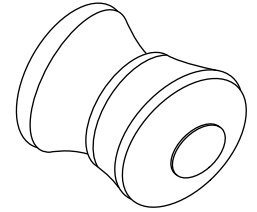



Colors/Finishes

- CP: Polished Chrome
- PB: Vibrant® Polished Brass

Accessories

- CP: Polished Chrome
- Other: Refer to Price Book for additional colors/finishes
- NA: None applicable

Specified Model

Model	Description				
		CP	PB	CP	PB
K-T15225-4	Valve trim with lever handles				
K-T15225-7	Valve trim with acrylic handles				
Required Accessories					
K-302-K	2-handle 1/2" ceramic disc valve system				<input type="checkbox"/> NA

Product Specification

Two-handle valve trim shall be of metal construction. Trim shall feature reversible 1/2" quarter-turn washerless ceramic disc valves. Product shall include lever or acrylic handles. Trim shall be Kohler Model K-T15225-____-____ and valve system shall be Kohler Model K-302-K-NA.

CORALAIS®

Optional Accessories			
56373	Deep roughing-in kit for wall-mount and shower faucets. For all handles except bath and shower faucets with stops	<input type="checkbox"/> CP	<input type="checkbox"/> Other ____
56374	Elongated escutcheons for bath and shower faucets with stops	<input type="checkbox"/> CP	<input type="checkbox"/> Other ____

Installation Notes

Install this product according to the installation guide.

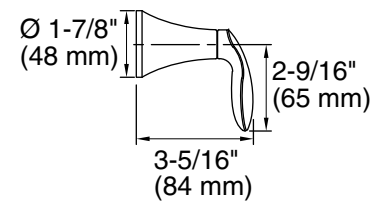
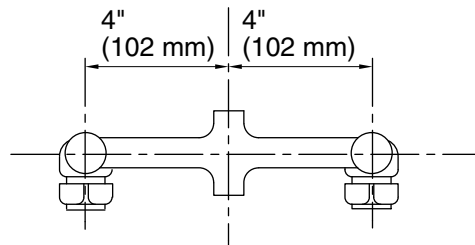
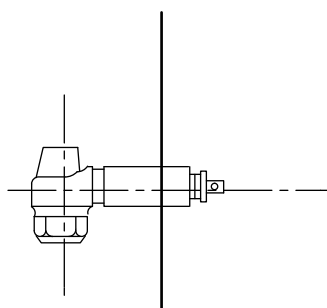

Lever

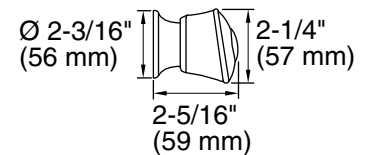

Acrylic

Product Diagram