

Features

- Two lever handles offer separate control of hot and cold water.
- 5-15/16" (151 mm) spout reach.
- 0.5 gpm (1.9 lpm) maximum flow rate at 60 psi (4.14 bar).
- KOHLER ceramic disc valves exceed industry longevity standards for a lifetime of durable performance.
- Clicker drain with tailpiece and overflow.
- Coordinates with other products in the Tone collection.

Material

- Premium material construction for durability and reliability.
- KOHLER finishes resist corrosion and tarnishing.

Installation

- For 8" - 16" (203 - 406 mm) centers.
- Deck-mount.
- Handles are preassembled on valves to simplify installation.

Water Conservation & Rebates

- This product can help a building earn Water Efficiency points in LEED® Green Building Rating System.

Recommended Products/Accessories

- K-23726 Drain treatment
- K-23723 Faucet cleaner
- K-27425 18" towel bar
- K-27426 24" towel bar
- K-27427 Robe hook
- K-27428 Towel ring
- K-27429 Pivoting toilet paper holder

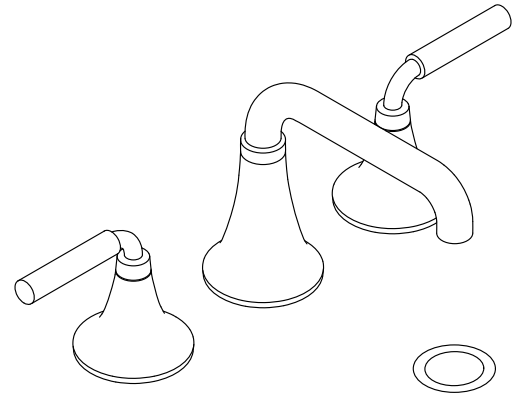

Codes/Standards







- ASME A112.18.1/CSA B125.1
- NSF/ANSI 61
- NSF/ANSI 372
- All applicable US Federal and State material regulations
- DOE - Energy Policy Act 1992
- California Energy Commission (CEC)
- ADA
- ICC/ANSI A117.1
- CSA B651
- OBC

KOHLER® Faucet Lifetime Limited Warranty

See website for detailed warranty information.

Available Colors/Finishes

Color tiles intended for reference only.

Color	Code	Description
	CP	Polished Chrome
	BN	Vibrant® Brushed Nickel
	BL	Matte Black
	2MB	Vibrant® Brushed Moderne Brass
	CBL	Matte Black with Polished Chrome
	BMB	Matte Black with Moderne Brass

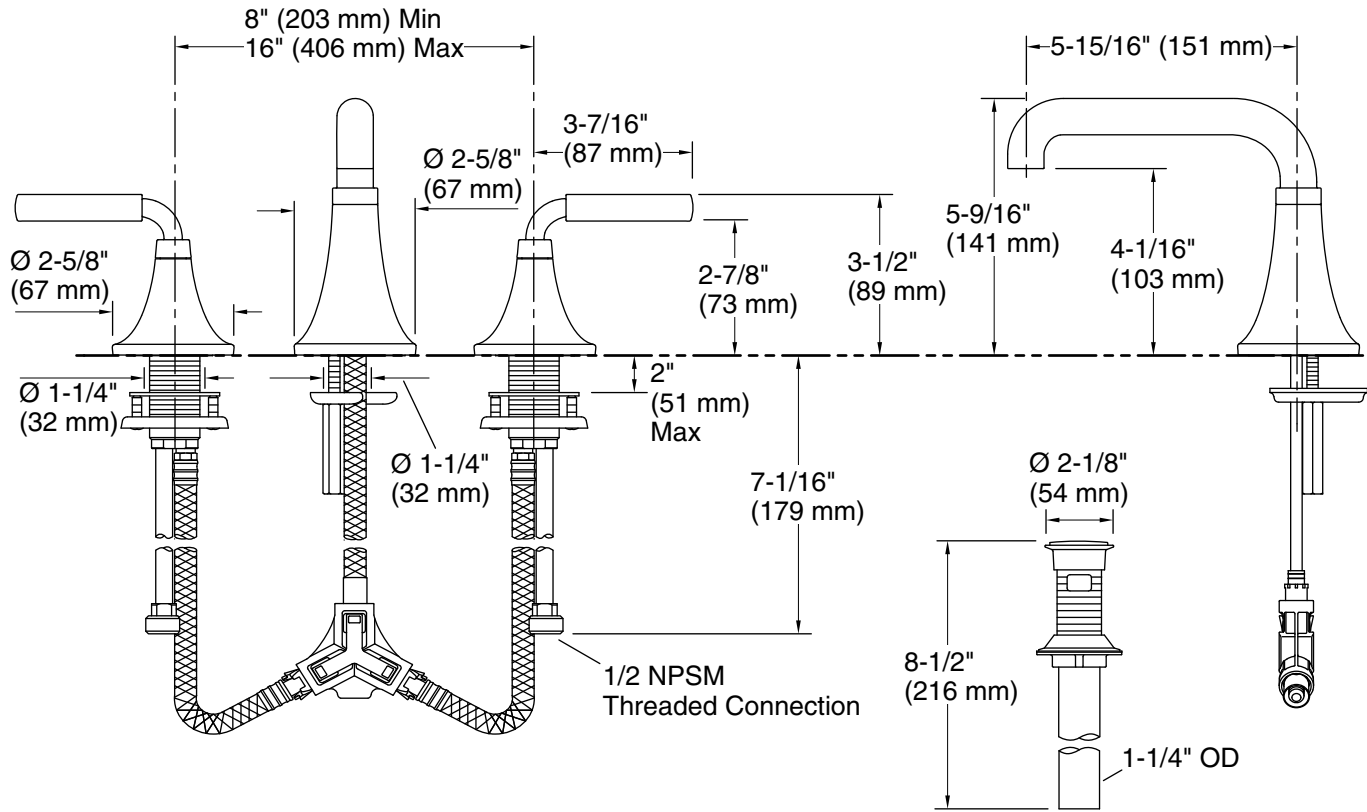

Technical Information

All product dimensions are nominal.

Faucet:

Flow rate: 0.5 gal/min (1.9 l/min)

Pressure: 60 psi (4.1 bar)

Drain included: Yes

Spout:

Spout reach: 5-15/16" (151 mm)

Notes

Install this product according to the installation instructions.

ADA, OBC, CSA B651 compliant when installed to the specific requirements of these regulations.