

### Features

- Two lever handles allow for both volume and temperature control.
- 6-3/8" (162 mm) spout reach.
- 1.2 gal/min (4.5 l/min) maximum flow rate [max at 60 psi (4.14 bar)].
- Includes metal pop-up drain with 1-1/4" tailpiece.
- KOHLER ceramic disc valves exceed industry longevity standards for a lifetime of durable performance.
- Handles pre-assembled on KOHLER Ultraglide™ Ceramic Disc Valves to simplify installation.
- Quick-Connect hose connections make widespread faucet installation a snap.
- Coordinates with Devonshire faucets, accessories, and showering components to complete your bathroom.

### Material

- Premium Metal Construction
- KOHLER finishes resist corrosion and tarnishing.

### Installation

- For 8" (203 mm) or 16" (406 mm) centers.
- Widespread



**ADA** **CSA B651** **OBC**

### Codes/Standards







ASME A112.18.1/CSA B125.1  
NSF/ANSI 61  
NSF/ANSI 372  
DOE - Energy Policy Act 1992  
EPA WaterSense®  
California Energy Commission (CEC)  
ADA  
ICC/ANSI A117.1  
CSA B651  
OBC

### KOHLER® Faucet Lifetime Limited Warranty

See website for detailed warranty information.

### Available Colors/Finishes

*Color tiles intended for reference only.*

Color	Code	Description
	CP	Polished Chrome
	SN	Vibrant® Polished Nickel
	PB	Vibrant® Polished Brass
	BN	Vibrant® Brushed Nickel
	BV	Vibrant® Brushed Bronze
	2BZ	Oil-Rubbed Bronze

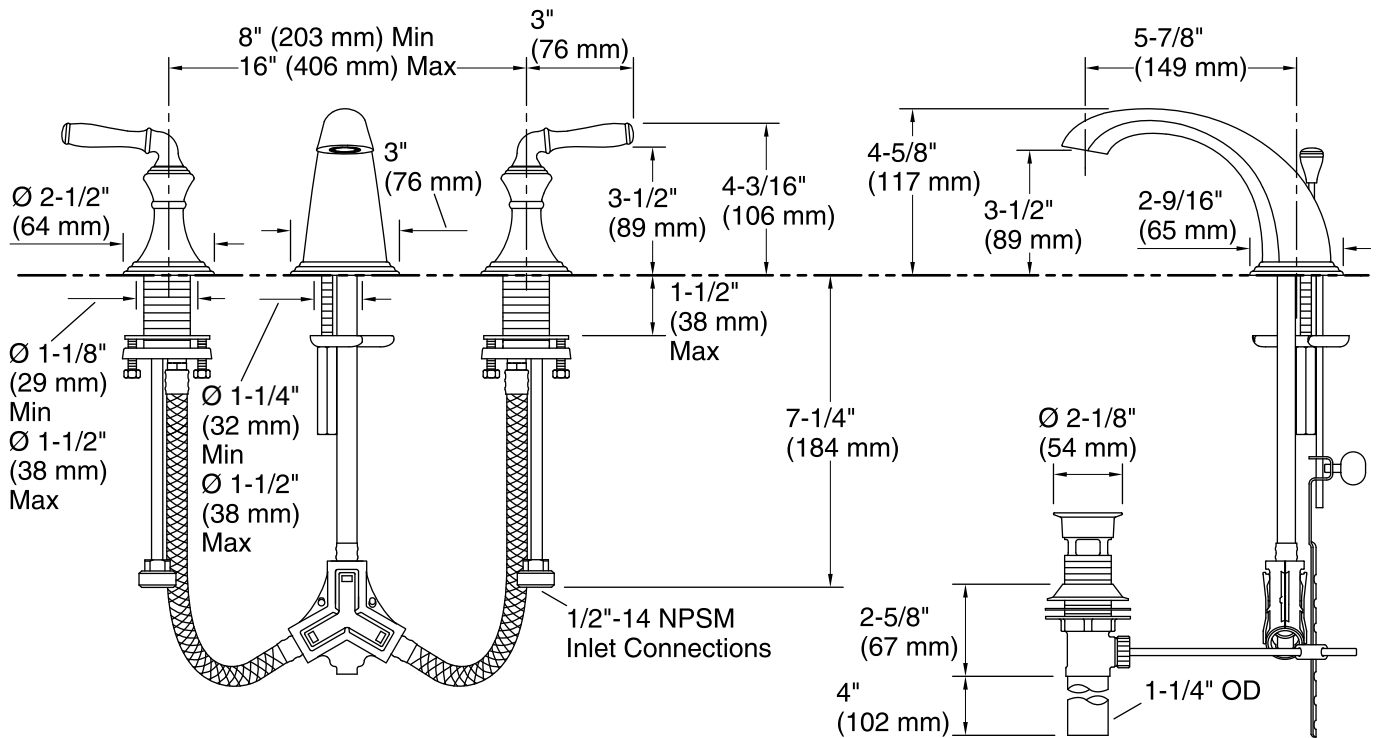

### Technical Information

All product dimensions are nominal.

#### Faucet:

Flow rate: 1.2 gal/min (4.5 l/min)

Pressure: 60 psi (4.1 bar)

Drain tailpiece included: Yes

#### Spout:

Spout reach: 6-3/8" (162 mm)

Handle clearance: 3" (76 mm)

### Notes

Install this product according to the installation guide.

ADA, OBC, CSA B651 compliant when installed to the specific requirements of these regulations.