

### Features

- Two Industrial handles offer separate control of hot and cold water
- For use with Components K-77967, K-77965, K-77968, K-77966, or K-77969 spout (sold separately)
- Coordinates with Components faucets, accessories, and showering components to complete your bathroom
- UltraGlide® valves with dry-stem technology are designed to eliminate common leak paths and provide smooth, effortless control

### Material

- Premium metal construction for durability and reliability
- KOHLER finishes resist corrosion and tarnishing

### Installation

- For 8" – 16" (203 – 406 mm) centers
- Handles are preassembled on valves to simplify installation

### Required Products/Accessories

K-77965 Bathroom sink faucet spout with Tube design, 1.2 gpm

or

K-77966 Bathroom sink faucet spout with Ribbon design, 1.2 gpm

or

K-77967 Bathroom sink faucet spout with Tube design, 1.2 gpm

or

K-77968 Bathroom sink faucet spout with Ribbon design, 1.2 gpm

or

K-77969 Bathroom sink faucet spout with Row design, 1.2 gpm

### Recommended Products/Accessories

K-23887 Bathroom sink faucet spout with Row design, 1.2 gpm

### Optional Products/Accessories

1303704 24" outlet hose assembly



### Codes/Standards

ASME A112.18.1/CSA B125.1

NSF/ANSI/CAN 61









NSF/ANSI/CAN 372

### KOHLER® Faucet Lifetime Limited Warranty

See website for detailed warranty information.

### Available Colors/Finishes

*Color tiles intended for reference only.*

Color	Code	Description
	CP	Polished Chrome
	SN	Vibrant® Polished Nickel
	AF	Vibrant® French Gold
	BN	Vibrant® Brushed Nickel
	BV	Vibrant® Brushed Bronze
	BL	Matte Black
	2MB	Vibrant® Brushed Moderne Brass
	TT	Vibrant Titanium
	BGP	Vibrant Brushed Graphite

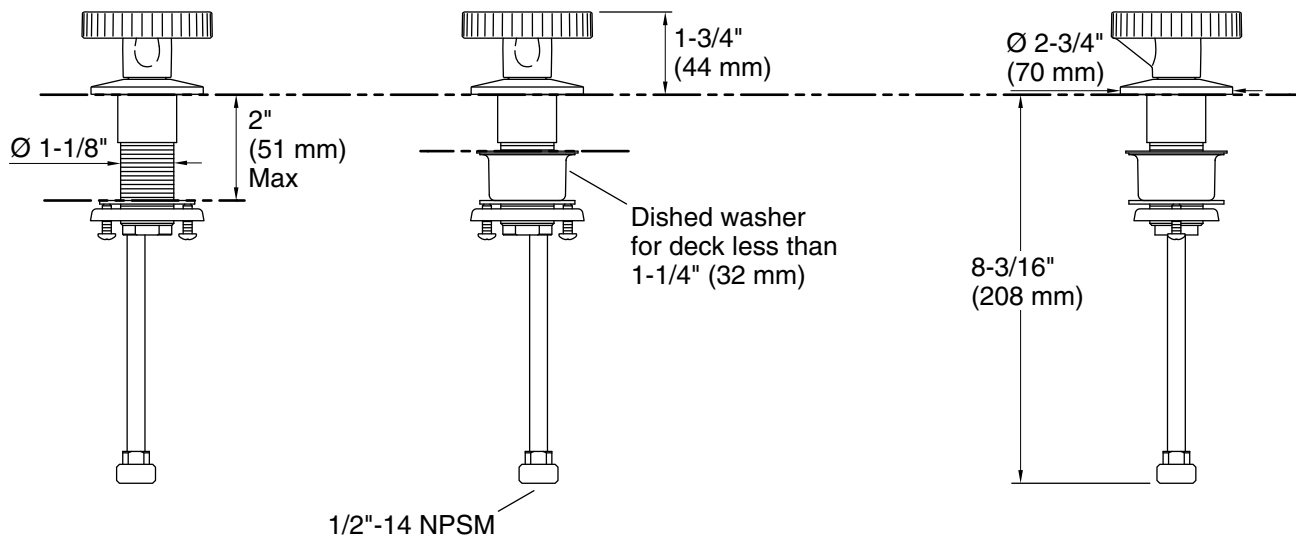

### Technical Information

All product dimensions are nominal.

### Spout:

### Notes

Install this product according to the installation instructions.