

**Westwood**  
*by Beckett*
**STEAM BOILER PARTS**

H7, -12

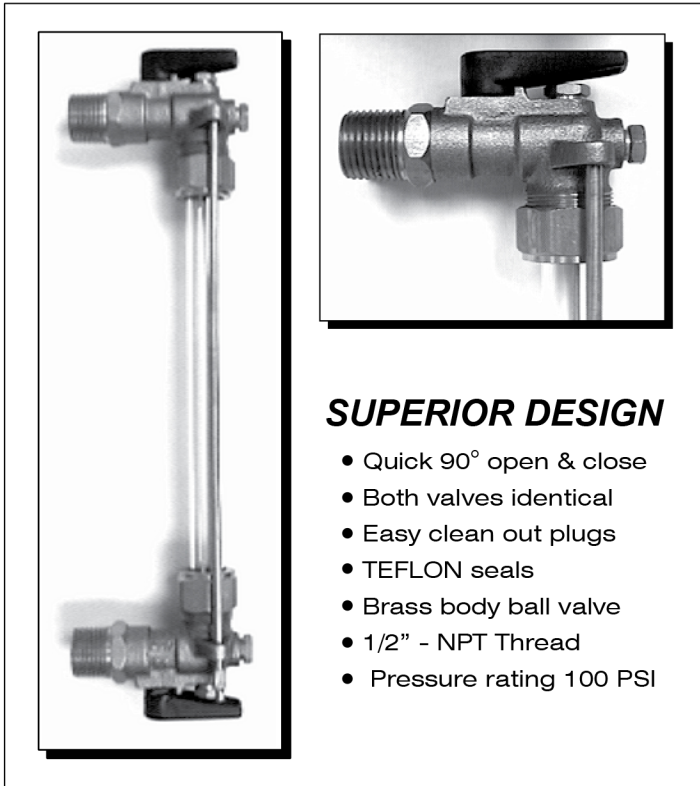

H7-20

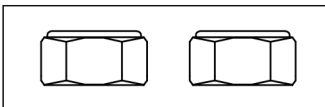
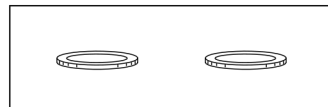

H7-21

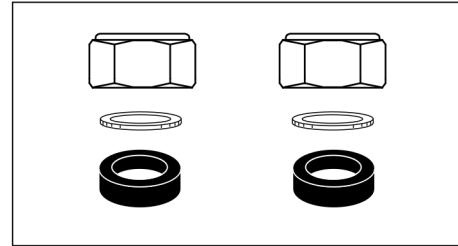

H7-17, -23

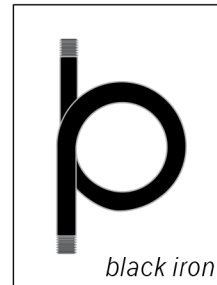

H7-50

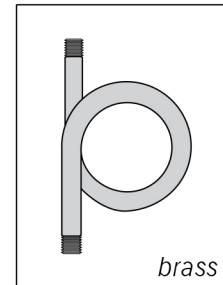

H7-52

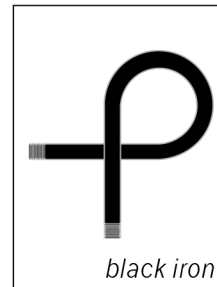

H7-55

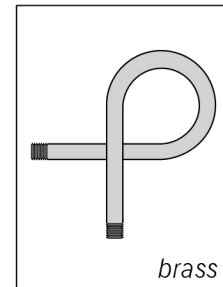

H7-57

**STEAM BOILER PARTS**

Item No.	Ref. No.	Description
H7	GV-22	Gauge Glass Set, 1/2" - NPT, w/Quick Open 90° Ball Valve, TEFLON Seals, Brass, w/10" rods
H7-12	-	Gauge Glass Set, 1/2" - NPT, w/Quick Open 90° Ball Valve, TEFLON Seals, Brass, w/12" rods & glass
H7-17	-	Repair Kit for H7 and H7-12, (2) ea. of nuts, friction washers, standard gauge glass washers
H7-20	-	Gauge glass nut, general replacement (not for H7 and H7-12), package of 2
H7-21	-	Gauge glass nut friction washer, universal replacement, package of 6
H7-23	-	Repair Kit, general replacement (not for H7 and H7-12), (2) ea. of nuts, friction washers, standard gauge glass washers
H7-50	-	Straight steam pig tail, black iron, 1/4"-NPT
H7-52	-	Straight steam pig tail, brass, 1/4"-NPT
H7-55	-	90° angle steam pig tail, black iron, 1/4"-NPT
H7-57	-	90° angle steam pig tail, brass, 1/4"-NPT