

Features

- 30" (762 mm) minimum base cabinet width
- Single bowl
- 12" (305 mm) depth provides generous workspace
- Offset drain increases workspace in the sink and storage space underneath
- Accessories stack and slide on ledges for a custom arrangement
- Wash bin features a deep tub, perfect for washing and soaking household items
- Stainless steel utility rack fits securely within the wash bin
- Matte finish offers rich, dimensional color
- No faucet holes; requires wall- or deck-mount faucet

Material

- KOHLER Neoroc® composite is durable and built to withstand day-to-day cleaning tasks
- Solid color throughout the sink
- Heat-resistant up to 750°F
- Scratch-, stain-, chip-, and thermal-shock-resistant

Installation

- Undermount
- Easy to install in a one-person, single-day project

Recommended Products/Accessories

- K-8801 Sink drain and strainer with tailpiece
- K-8799 Sink drain and strainer basket
- K-23726 Drain treatment
- K-23725 Cast iron cleaner

Optional Products/Accessories

- K-11352 Disposal Flange with Stopper
- K-9000 P-Trap

Included Components

Additional Components:

- 27788
- 27789



Codes/Standards







CSA B45.5/IAPMO Z124

KOHLER® Neoroc® Sinks Lifetime Limited Warranty

See website for detailed warranty information.

Available Colors/Finishes

Color tiles intended for reference only.

| Color | Code | Description |
|---|------|----------------|
|  | CM6 | Matte White |
|  | CM7 | Matte Graphite |
|  | CM2 | Matte Brown |
|  | CM3 | Matte Taupe |
|  | CM1 | Matte Black |
|  | CM4 | Matte Grey |

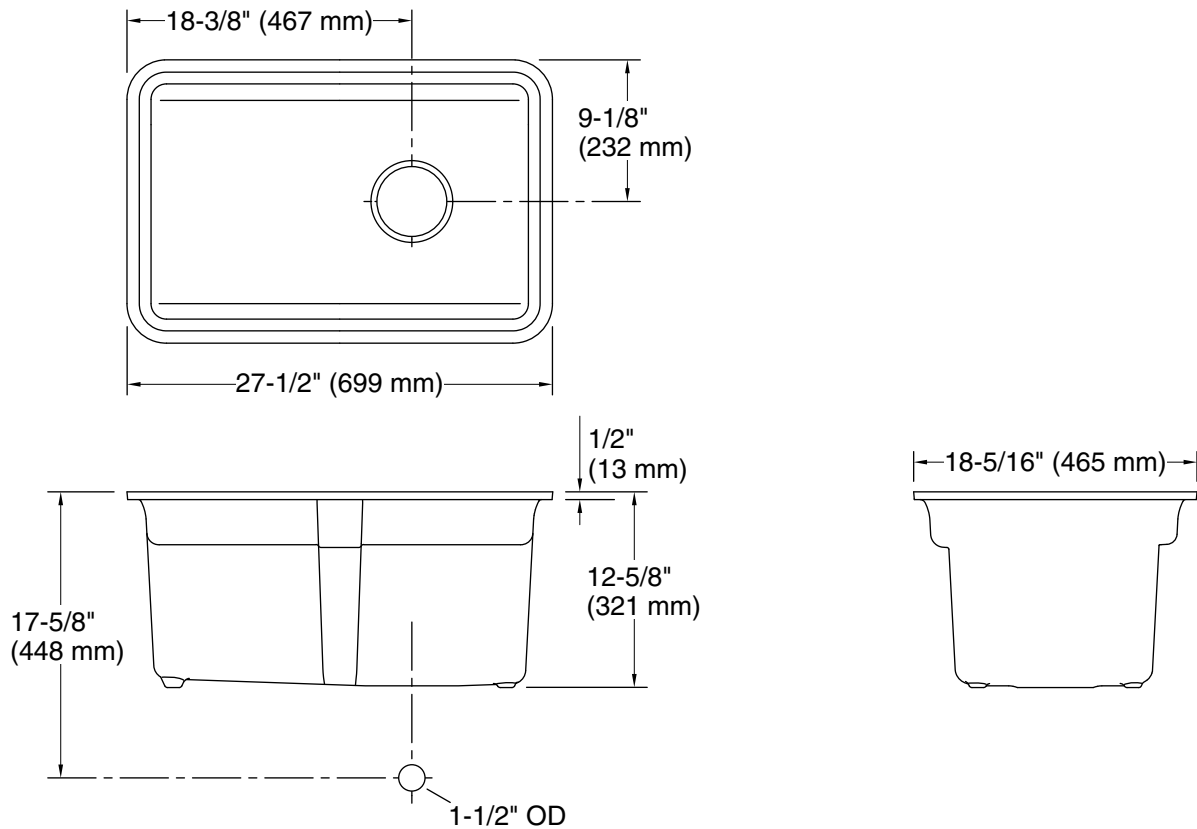

Technical Information

All product dimensions are nominal.

| | |
|--------------------------|--|
| Bowl configuration: | Single |
| Installation: | Undermount |
| Min. base cabinet width: | 30" (762 mm) |
| Bowl area (Only): | Length: 24-3/8" (620 mm) Width: 15-3/8" (391 mm) Bowl depth: 12" (305 mm) Water depth: 12" (305 mm) |
| With overflow: | No |
| Drain hole: | 3-7/8" (98 mm) |
| Template: | Undermount, 1311528-7, required, included |

Notes

Install this product according to the installation instructions.

NOTICE: Countertop manufacturer or cutter must use the cut-out template provided with the product, or a current one provided by Kohler Co. (call 1-800-4-KOHLER). Kohler Co. is not responsible for cutout errors when the incorrect cut-out template is used.