

Features

- Advanced spray engine provides three experiences: full coverage, pulsating massage, and silk spray.
- Full coverage spray produces an encompassing spray for everyday use and utilizes Katalyst® air induction to create large, full drops.
- Pulsating massage spray targets sore muscles to ease away aches and pains.
- Silk spray releases a dense, luxurious spray ideal for rinsing.
- MasterClean™ spray nozzles prohibit mineral build-up for easy cleaning.
- Thumb tab allows for a smooth transition between sprays.
- MasterClean™ spray nozzles prohibit mineral buildup for easy cleaning.
- 1.75 gpm (gallons per minute) flow rate.
- Shower arm and flange not included.

Material

- KOHLER finishes resist corrosion and tarnishing.

Installation

- Coordinates with Forté®, Alteo®, and Refinia® faucets and accessories.
- 1/2-inch - 14 NPT connection.
- Wall-mount.

Water Conservation & Rebates

- This product can help a building earn Water Efficiency points in the LEED® Green Building Rating System.
- WaterSense®-labeled 1.75-gpm showerheads use up to 30 percent less water than standard 2.5-gpm showerheads while still meeting strict performance guidelines.
- This product can help a building earn Water Efficiency points in the LEED® Green Building Rating System.

Recommended Products/Accessories

- K-7397 Shower Arm and Flange
- K-7395 Shower Arm and Flange



Codes/Standards





ASME A112.18.1/CSA B125.1
DOE - Energy Policy Act 1992
EPA WaterSense®
California Energy Commission (CEC)

KOHLER® Faucet Lifetime Limited Warranty

See website for detailed warranty information.

Available Colors/Finishes

Color tiles intended for reference only.

Color	Code	Description
	CP	Polished Chrome
	SN	Vibrant® Polished Nickel
	AF	Vibrant® French Gold
	BN	Vibrant® Brushed Nickel
	BV	Vibrant® Brushed Bronze

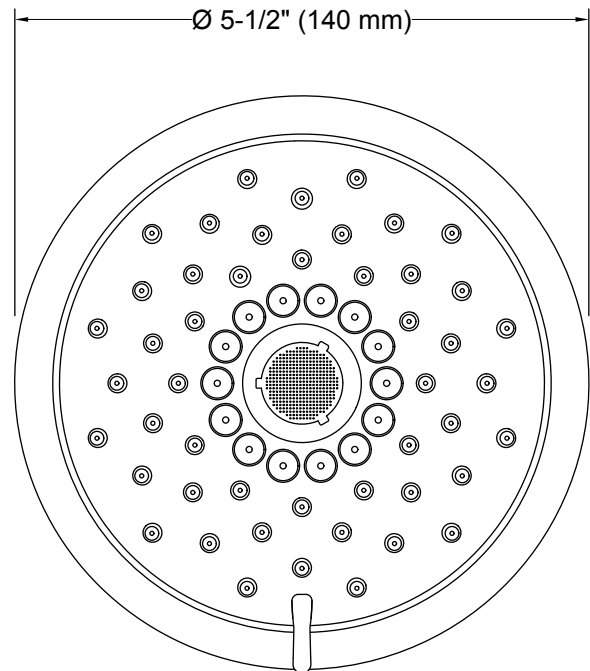
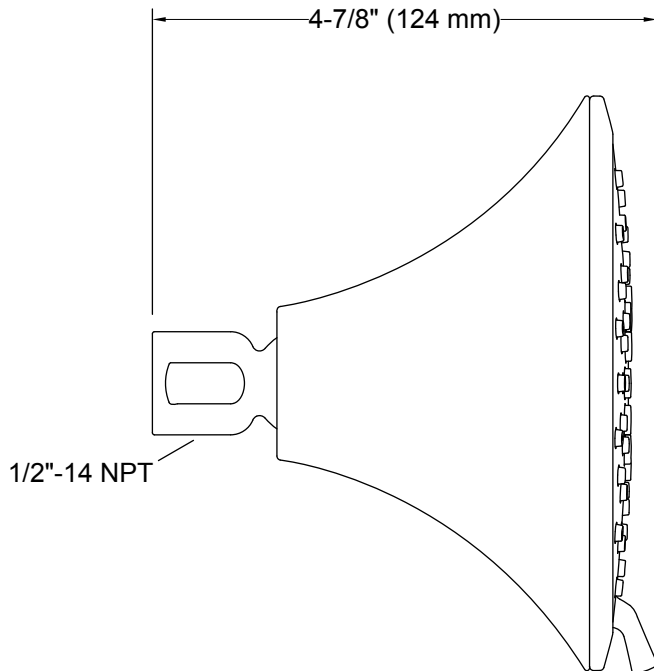

Technical Information

All product dimensions are nominal.

Showerhead/Body Spray:

Rated maximum flow: 1.75 gal/min (6.6 l/min)

Notes

Install this product according to the installation instructions.