

### Features

- 36-inch minimum base cabinet width.
- Acid-resistant enamel finish.
- Under-mount.
- Single bowl.
- No faucet holes.
- Offset drain basin slopes toward drain to minimize water from pooling.
- Self-Trimming® apron overlaps cabinet face for easy installation and beautiful results.
- Shortened apron allows sink to be used in most standard cabinetry or retrofitted to existing standard cabinetry.
- 35-1/2" (902 mm) x 21-9/16" (548 mm)

### Material

- KOHLER® enameled cast iron.
- Strainer not included.

### Recommended Accessories

K-9000 P-Trap  
K-6639 Sink Rack  
K-6377 Sponge Caddy  
K-6378 Kitchen Brush Caddy  
K-6379 Kitchen Squeegee  
K-6382 Disinfecting Wipes Dispenser  
K-6383 Soap Dispenser  
K-8618 Paper Towel Holder  
K-8619 Flexible Kitchen Mat  
K-8624 Dish Scraper  
K-8801 Sink Strainer  
K-8799 Sink Strainer



### Codes/Standards















ASME A112.19.1/CSA B45.2

### KOHLER® Enameled Cast Iron Kitchen Sink Lifetime Limited Warranty

See website for detailed warranty information.

### Available Color/Finishes

*Color tiles intended for reference only.*

Color	Code	Description
	0	White
	FF	Sea Salt™
	96	Biscuit
	47	Almond
	FD	Cane Sugar™
	NY	Dune
	95	Ice™ Grey
	G9	Sandbar
	K4	Cashmere
	FT	Basalt
	58	Thunder™ Grey
	KA	Black 'n Tan
	FP	Caviar
	7	Black Black™

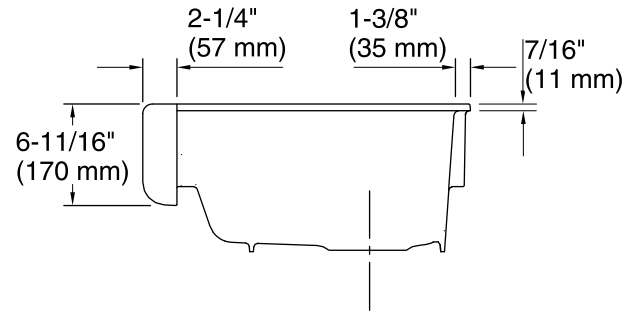
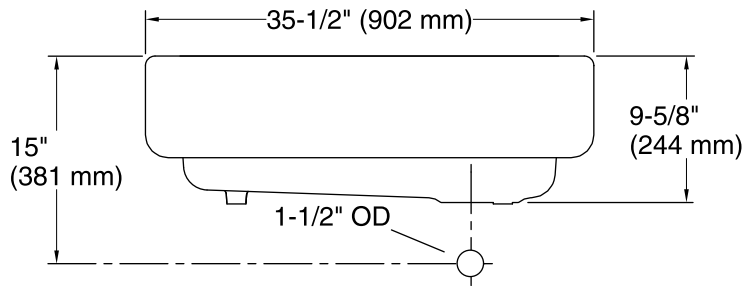
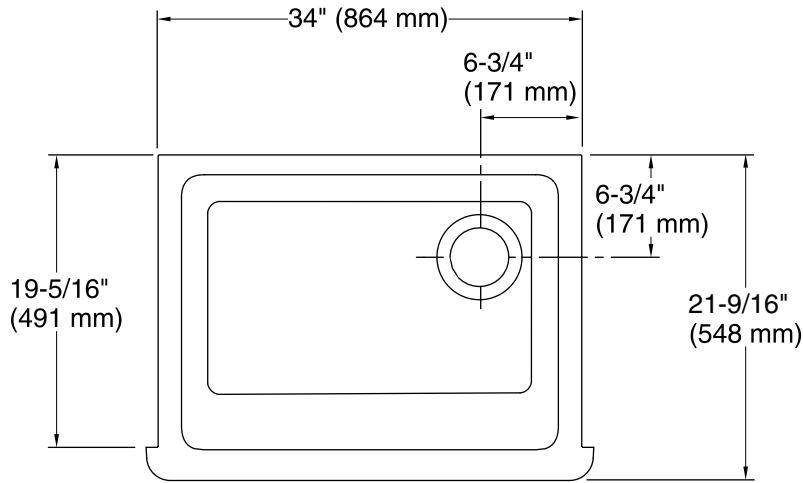

### Technical Information

All product dimensions are nominal.

Bowl configuration:	Single
Installation:	Under-mount
Min. base cabinet width:	36" (914 mm)
Bowl area (Only):	Length: 30-3/4" (781 mm) Width: 18-1/16" (459 mm) Bowl depth: 9" (229 mm)
Drain hole:	3-5/8" (92 mm)
Template:	1156910-7, required, included 1211449-7, required, included

### Notes

Install this product according to the installation instructions.

**NOTICE:** Countertop manufacturer or cutter must use the current product template available at [www.kohler.com](http://www.kohler.com), or by calling 1-800-4KOHLER. Kohler Co. is not responsible for cutout errors when the incorrect cutout template is used.

**IMPORTANT!** The distance from the top edge of the cabinet to the top of the cabinet door must be at least 6-7/8" (175 mm) to install this sink.