

This unit offers NO anti-siphon or backflow protection.



Freezeless Wall Faucet Model 14

The freezeless Woodford Model 14 is designed and intended for year-round residential irrigation purposes regardless of outside temperature. This faucet will not rupture from freezing when the valve is shut off and the hose is removed.

SPECIFICATIONS:

- Manufactured under one or more of the following patents:
For Patent Information see:
[HTTP://www.Woodfordmfg.com/Patents](http://www.Woodfordmfg.com/Patents)
- CSA Approved 

FEATURES:

- 3/4" male hose thread nozzle
- Stainless steel seat - eliminates wire draw
- EPDM packing to prevent leaking
- Full circle operating threads on valve body and retainer
- No-lead solder
- Standard "O" size seat washer
- Powder-coated, die cast aluminum handle
 - Optional Tee Key available (extra charge)
- Adjustable polycarbonate wall flange
- **MAX PRESSURE** - 125 p.s.i.

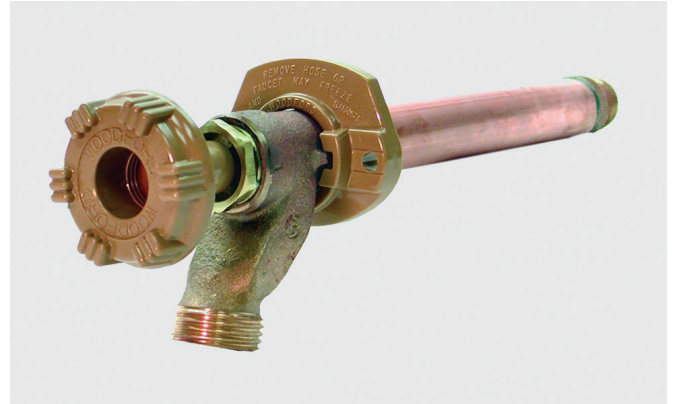

WARNING - Faucet must be installed with downward pitch toward nozzle and hose must be removed in freezing weather or faucet may freeze and burst.
Not intended for continuous use applications.

Rough-In Dimensions

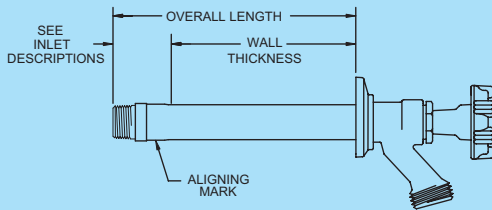

Wall Thickness (inches)





4	6	8	10	12	14	16	18	20	22	24
1.2	1.3	1.4	1.5	1.6	1.7	1.8	1.9	2.0	2.1	2.2

Shipping Wt. Ea. (lbs)

*Overall Length Dimension: Add wall thickness and inlet option length shown in chart above.

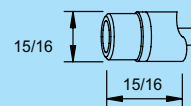
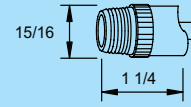
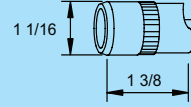
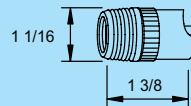
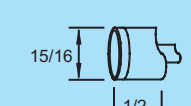
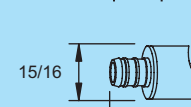
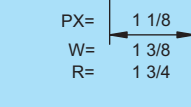
For Installation / Troubleshooting Instructions go to www.woodfordmfg.com or call 1-800-621-6032

Inlet Descriptions

	<p>C Inlet COMBINATION Copper Sweat Fitting 1/2" K, L or M Inside 3/4" M Only Outside</p>
	<p>CP Inlet COMBINATION 1/2" Male Pipe Thread 1/2" Female Sweat</p>
	<p>C3 Inlet 3/4" Female Sweat Fitting</p>
	<p>P Inlet COMBINATION 1/2" Female Pipe Thread 3/4" Male Pipe Thread</p>
	<p>C1 INLET 1/2" Female Sweat Fitting</p>
	<p>PX Inlet 1/2" PEX Tube Fitting</p>
	<p>PX3 INLET 3/4" PEX Tube Fitting</p>
	<p>W Inlet 1/2" Wirsbo Tube Fitting</p>
	<p>W3 INLET 3/4" Wirsbo PEX Tube Fitting</p>
	<p>R Inlet 1/2" Rehau Tube Fitting</p>
	<p>CM Inlet COMBINATION 1/2" Compression Fitting 1/2" Copper Sweat Fitting</p>

When ordering, specify model , inlet and wall thickness.

WOODFORD

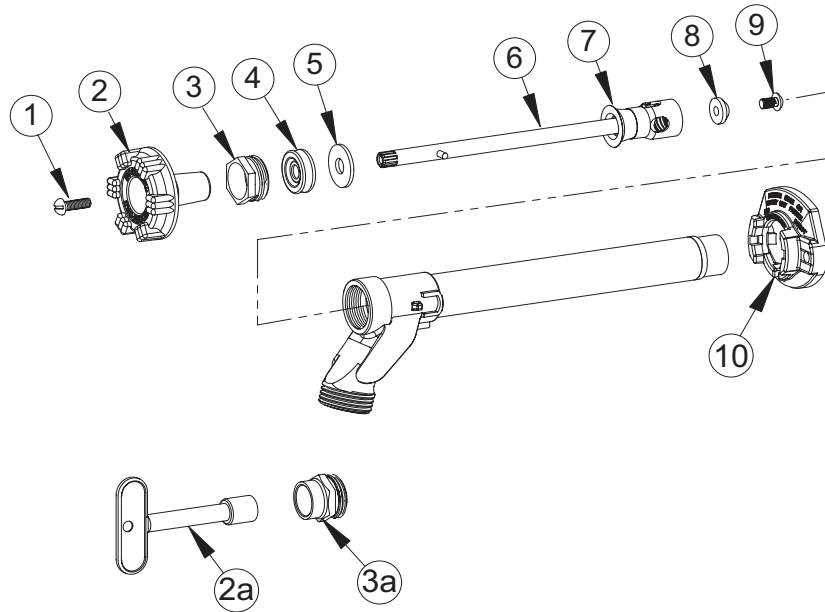

MODEL 14 PARTS LIST

ITEM	PART#	DESCRIPTION
1	30002	Handle Screw
2	30096	Wheel Handle - Round Powder Coated Die Cast Aluminum
2a	50012	Tee Key (Optional)
3	30059	Packing Nut
3a	30512	Packing Nut w/deep stem guard (Optional)
4	30560	EPDM Packing
5	30006	Packing Support Washer
6	35XXX	Valve Stem Assembly (See chart at right) Includes Items 7, 8 & 9
7	30459	Check Valve
8	30008	Valve Seat Rubber
9	30009	Retainer Screw
10	30098	Adjustable Flange
	RK-14MH	Repair Kit (Includes items 1, 2, 3, 4, 5, 8 & 9)

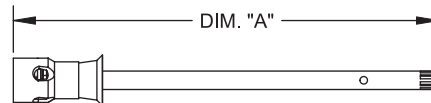

VALVE STEM ASSEMBLY DIM "A"		
Wall Thickness	Overall Length	Part No.
CC (1 3/4)	3 5/8"	35942
4	5 7/8"	35720
6	7 7/8"	35721
8	9 7/8"	35722
10	11 7/8"	35723
12	13 7/8"	35724
14	15 7/8"	35725
16	17 7/8"	35736
18	19 7/8"	35726
20	21 7/8"	35737
22	23 7/8"	35738
24	25 7/8"	35727



For more information contact...

WOODFORD MANUFACTURING COMPANY

2121 Waynoka Road, Colorado Springs, Colorado 80915 • Phone: (800) 621-6032 • Fax: (800) 765-4115
 To view our complete product line visit: www.woodfordmfg.com or email: sales@woodfordmfg.com

A Division Of WCM Industries, Inc.