

Features

- 36" minimum base cabinet width.
- Single bowl.
- 9-1/2" depth provides generous workspace.
- Offset drain increases workspace in the sink and storage space underneath.
- Includes K-5196 sink rack.
- Includes cutout templates and installation clips.

Material

- KOHLER Neoroc® composite is durable and built to withstand day-to-day cleaning tasks.
- Matte finish offers rich, dimensional color.
- Solid color throughout the sink.
- Heat-resistant up to 750°F.
- Scratch, stain, chip, and thermal-shock resistant.

Installation

- Undermount.
- Easy to install in a one-person, single-day project.

Recommended Products/Accessories

- K-5192 Small stainless steel sink rack for K-8206
- K-8801 Sink drain and strainer with tailpiece
- K-8799 Sink drain and strainer basket
- K-23726 Drain treatment
- K-23730 Neoroc® cleaner

Optional Products/Accessories

- K-11352 Disposal Flange with Stopper
- K-9000 P-Trap

Included Components

- Product consists of:
K-5196 Sink Rack



Codes/Standards









CSA B45.5/IAPMO Z124

KOHLER® Neoroc® Sinks Lifetime Limited Warranty

See website for detailed warranty information.

Available Colors/Finishes

Color tiles intended for reference only.

| Color | Code | Description |
|---|------|------------------|
|  | CM6 | Matte White |
|  | CM7 | Matte Graphite |
|  | CM5 | Matte Beige |
|  | CM8 | Matte Black Plum |
|  | CM1 | Matte Black |
|  | CM2 | Matte Brown |
|  | CM3 | Matte Taupe |
|  | CM4 | Matte Grey |

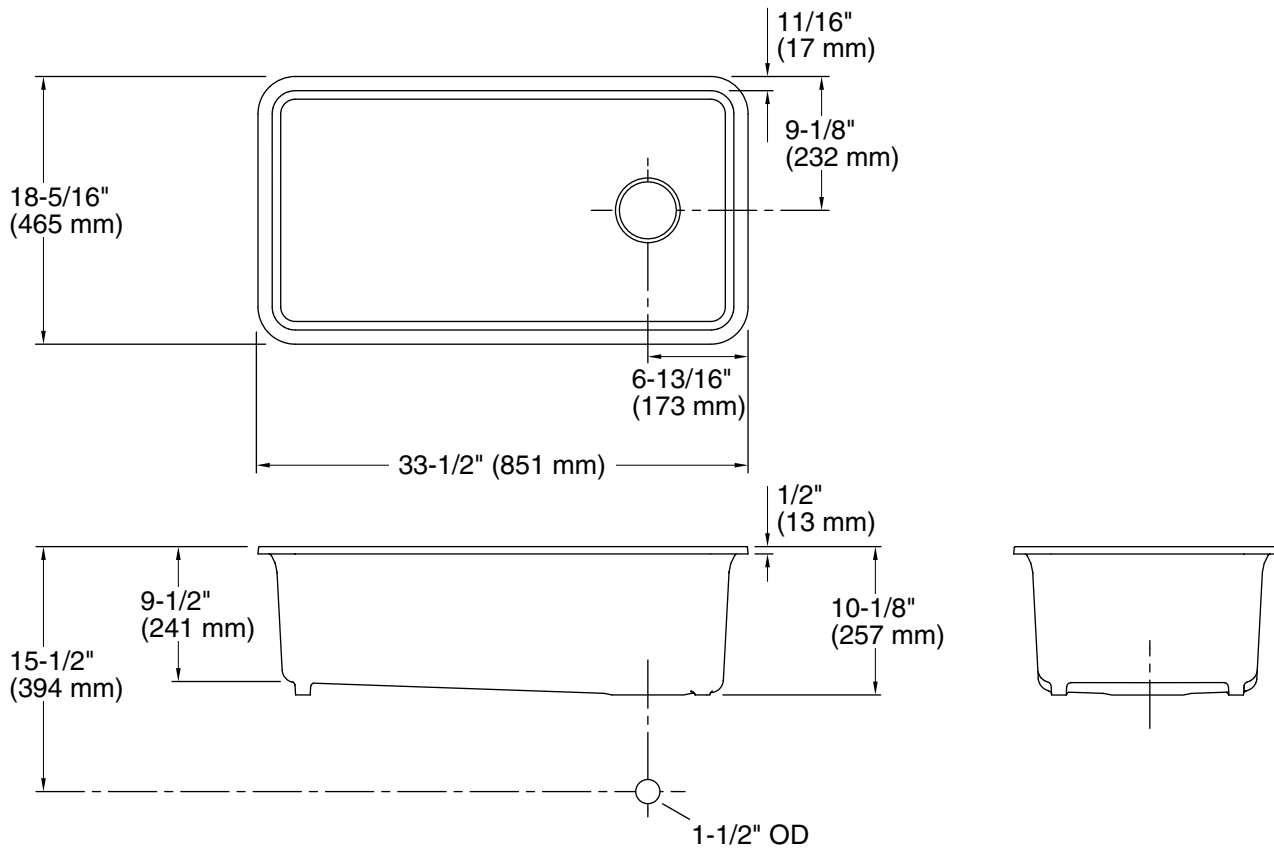

Technical Information

All product dimensions are nominal.

Bowl configuration: Single

Installation: Under-mount

Min. base cabinet width: 36" (914 mm)

Bowl area (Only):
 Length: 30-9/16" (777 mm)
 Width: 15-3/8" (391 mm)
 Bowl depth: 9-1/2" (241 mm)
 Water depth: 9-1/2" (241 mm)

Drain hole: 3-7/8" (98 mm)

Template: 1256394-7, required, included

Notes

Install this product according to the installation instructions.

Allow a minimum of 2" (51 mm) clearance around the sink rim for clip attachment.