

Features

- Bask® heated surface creates spa-like relaxation with soothing warmth on your back, shoulders, and neck.
- Three heat settings allow you to customize the surface temperature.
- 120 airjets release thousands of heated bubbles that surround and support the body in a warm massage.
- Variable-speed blower lets you adjust massage intensity to 18 levels.
- Heated BubbleMassage™ includes 60-minute automatic shutoff timer.
- Two separate electronic keypad controls for Heated BubbleMassage™ and Bask®.
- Hourglass shape adds style and elegance to your bathroom.
- Integral apron.
- Integral flange helps prevent water from seeping behind wall and simplifies alcove installation.
- Textured bottom surface.
- Automatic and manual purge cycles remove residual water from air channels after use.
- Bask® heated surface creates spa-like relaxation with soothing warmth on your back, shoulders, and neck.

Material

- Acrylic.

Technology

- Heated BubbleMassage™ technology warms and humidifies air before it enters the bath.

Installation

- Right drain.

Recommended Products/Accessories

- K-1446 Remote Installation Kit
- K-1491 Bath/Whirlpool Pillow
- K-1601 Bath/whirlpool footstop, removable
- K-24916 Wireless Music Kit
- K-23726 Drain treatment
- K-23732 Tub & shower cleaner
- K-37380 30" Rough-in Cable Bath Drain
- K-37383 Rough-in cable bath drain, PVC, 30" cable with tubing
- K-7265 Brass toe tap bath drain
- K-37386 rough-in cable drain, PVC, 30" cable



Codes/Standards

ASME A112.19.7/CSA B45.10
CSA B45.5/IAPMO Z124
ASTM E162
ASTM E662
UL 1795



KOHLER® Hydrotherapy Components Five-Year Limited Warranty KOHLER® Plastic Baths and Receptors Lifetime Limited Warranty

See website for detailed warranty information.

Available Colors/Finishes

Color tiles intended for reference only.

Color Code Description

	0	White
	96	Biscuit
	NY	Dune

No change in measurements if connected with drain illustrated. (K-7272)

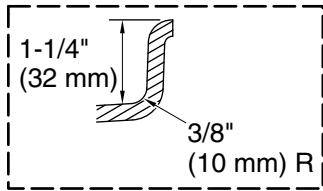

Integral Flange Detail

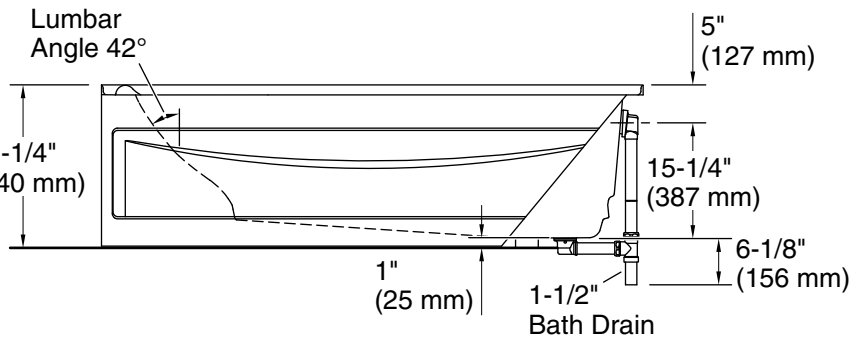
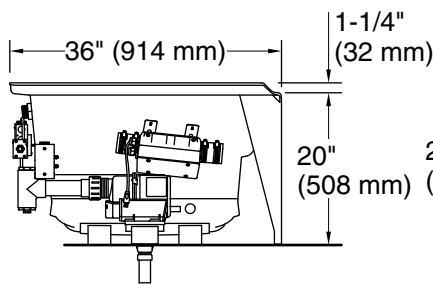
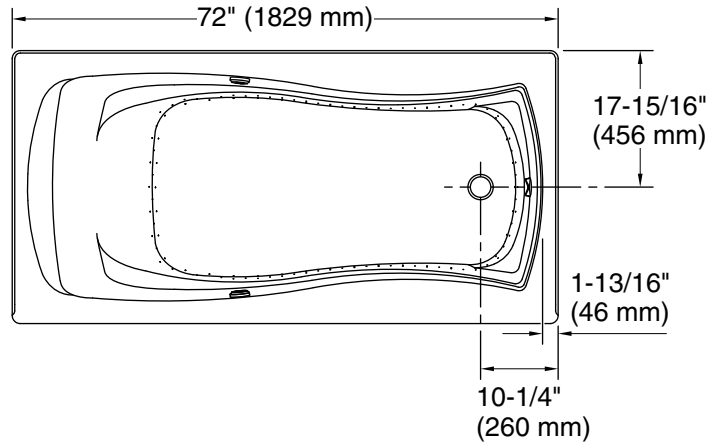

Required Electrical Service

Two dedicated circuits required, protected with Class A Ground-Fault Circuit-Interrupter (GFCI). Outside North America, this device may be known as a Residual Current Device (RCD).

Blower, Heated Surface:	120 V, 15 A, 60 Hz
Air bath:	120 V, 15 A, 60 Hz

Technical Information

All product dimensions are nominal.

Installation:	Three-wall alcove
Drain location:	Right
Basin area, bottom:	47-15/16" x 20-1/16" (1218 mm x 510 mm)
Basin area, top:	65-3/8" x 25" (1660 mm x 636 mm)
Weight:	121 lbs (54.9 kg)
Minimum floor load:	41 lbs/ft ² (200.2 kg/m ²)
Water depth:	13-3/8" (340 mm)
Water capacity:	72 gal (272.5 L)
Electrical component rating:	Blower: 120 V, 10 A, 60 Hz Heated Surface: 120 V, 0.5 A, 60 Hz, 65 W Air bath: 120 V, 5 A, 60 Hz

Notes

Measure your actual product for rough-in details.

Install this product according to the installation instructions.

The hot water supply should be 70% of the capacity of the bath or greater. Installations will vary.

Remote blower installation kit K-1446 is available for relocating the blower. Provide access for servicing the blower.

Do not relocate or alter the PVC tee or coiled flexible tubing connected to the blower. Follow the blower relocation instructions exactly.