

KOHLER® Faucets

8" rainhead with Katalyst® air-induction technology, 1.75 gpm
K-13692-G

Features

- Single-function rain showerhead.
- MasterClean™ sprayface features an easy-to-clean surface that withstands mineral buildup.
- Katalyst® Spray Technology with air induction ball joint.
- Optimized sprayface for maximum performance.
- 1.75 gpm (6.6 lpm) maximum flow rate.

Material

- Solid brass construction for durability and reliability.

Installation

- 1/2" - 14 NPT connection.

Recommended Products/Accessories

K-23723 Faucet cleaner

Optional Products/Accessories

K-7394 Shower Arm



Codes/Standards

ASME A112.18.1/CSA B125.1

DOE - Energy Policy Act 1992

EPA WaterSense®







California Energy Commission (CEC)

KOHLER® Faucet Lifetime Limited Warranty

See website for detailed warranty information.

Available Colors/Finishes

Color tiles intended for reference only.

Color	Code	Description
	CP	Polished Chrome
	SN	Vibrant® Polished Nickel
	AF	Vibrant® French Gold
	BN	Vibrant® Brushed Nickel
	BV	Vibrant® Brushed Bronze
	2BZ	Oil-Rubbed Bronze

1-800-4KOHLER (1-800-456-4537)

Kohler Co. reserves the right to make revisions without notice to product specifications.

For the most current Specification Sheet, go to www.kohler.com.

9-5-2020 11:44 - US/CA

THE BOLD LOOK
OF **KOHLER**®

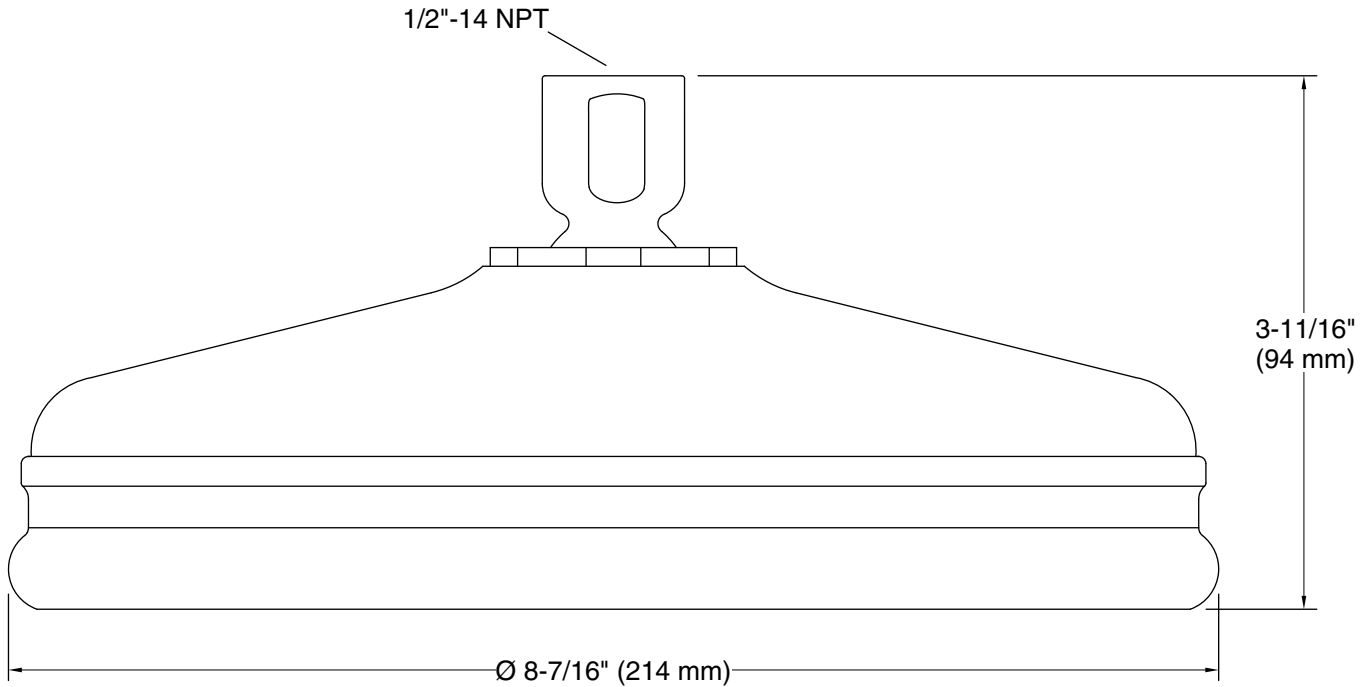

Technical Information

All product dimensions are nominal.

Faucet:

Flow rate: 2.5 gal/min (9.5 l/min)

Showerhead/Body Spray:

Rated maximum flow: 1.75 gal/min (6.6 l/min)

Pressure: 80 psi (5.5 bar)

Notes

For use with automatic compensating valves rated at 1.5 gal/min (5.7 l/min) or less.

Install this product according to the installation instructions.