

KOHLER® Faucets

Bathroom sink faucet spout with Cane design, 0.5 gpm
K-27008-N

Occasion™

Features

- 6" (152 mm) spout reach
- 0.5 gpm (1.9 lpm) maximum flow rate at 60 psi (4.14 bar)
- Laminar flow delivers a graceful stream of water
- Includes metal pop-up drain with 1-1/4" tailpiece
- Part of the Occasion bathroom faucet and accessory collection

Material

- Premium metal construction for durability and reliability
- KOHLER finishes resist corrosion and tarnishing

Installation

- For 8" - 16" (203 - 406 mm) centers
- Deck-mount

Required Products/Accessories

K-27010-3 Cross bathroom sink faucet handles

or

K-27010-4 Lever bathroom sink faucet handles

or

K-27010-9 Knob bathroom sink faucet handles

Recommended Products/Accessories

K-23723 Faucet cleaner



Codes/Standards

ASME A112.18.1/CSA B125.1

NSF/ANSI/CAN 61

NSF/ANSI/CAN 372

All applicable US Federal and State material regulations

DOE - Energy Policy Act 1992

California Energy Commission (CEC)

KOHLER® Faucet Lifetime Limited Warranty

See website for detailed warranty information.

Available Colors/Finishes

Color tiles intended for reference only.

Color	Code	Description
	SN	Vibrant® Polished Nickel
	BL	Matte Black
	2MB	Vibrant® Brushed Moderne Brass

1-800-4KOHLER (1-800-456-4537)

Kohler Co. reserves the right to make revisions without notice to product specifications.

For the most current Specification Sheet, go to www.kohler.com.

1-25-2023 22:23 - US/CA/CN/IN/MX

THE BOLD LOOK
OF **KOHLER®**

KOHLER Faucets Bathroom sink faucet spout with Cane design, 0.5 gpm
Occasion™
K-27008-N

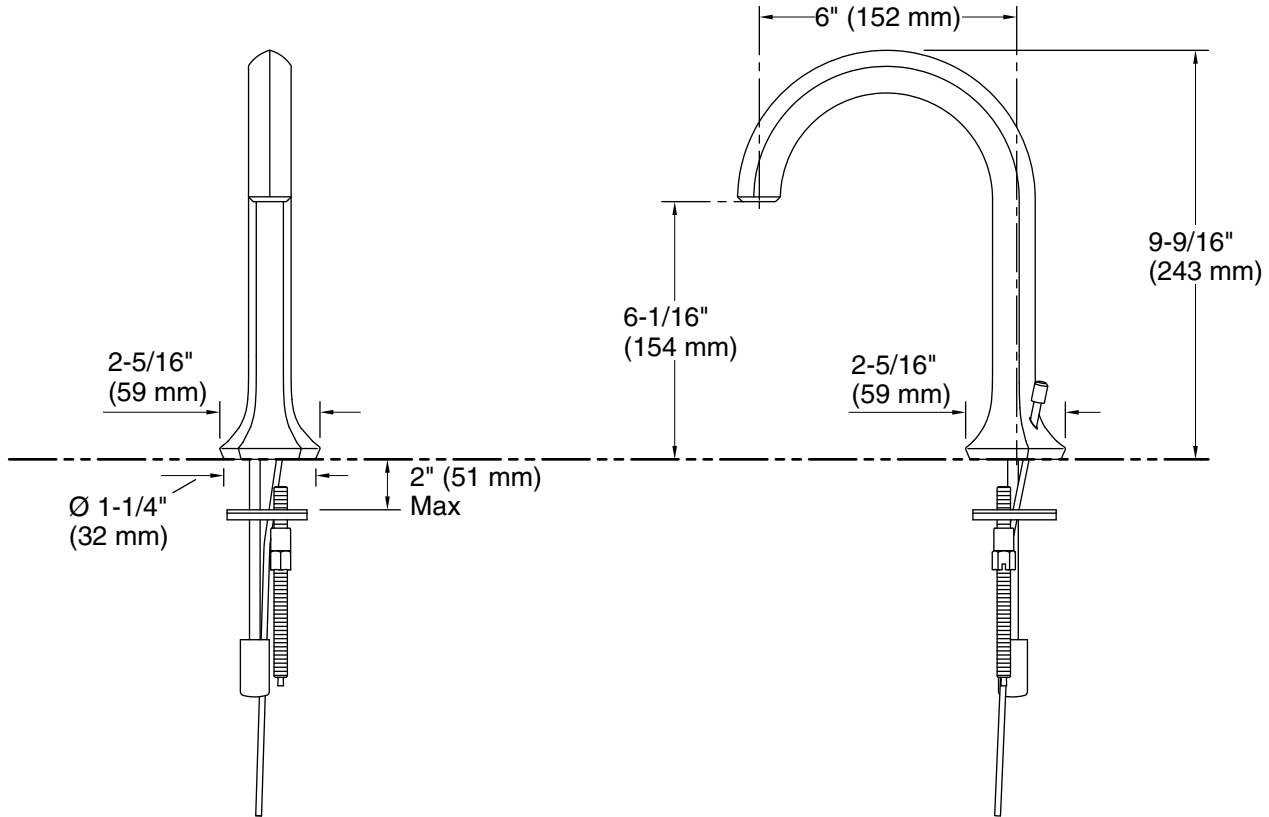

Technical Information

All product dimensions are nominal.

Faucet:

Flow rate: 0.5 gal/min (1.9 l/min)

Pressure: 60 psi (4.1 bar)

Drain included: Yes

Drain with overflow: Yes

Notes

Install this product according to the installation instructions.