

Single Control Widespread Faucet

TECK[®]
COMMERCIAL

DELTA[®]

Specification: (example)

- Widespread single control faucet
 - 102 to 406mm (4" to 16") adjustable centers
 - Polished chrome plated finish
 - **DELTA[®]** washerless stainless steel ball
 - Handle rotation limit stop
 - 3/8" IPS **BRASS PIPE** Rigid/Swivel Gooseneck spout
 - Metal trim, colour indexed vandal resistant lever blade handle
- and ...
with ... (add product variation required)
with ... (add outlet required)
with ... (add suffix **-LS** if required – See Back Page)



Engineer/Architect Approval









Model Specified:

Approval:

Date:

DESCRIPTION	PRODUCT NO.			
Single Control Widespread Faucet	24T2	6		3
Control Unit Only	24T0	0	0	3



PRODUCT VARIATION	OUTLET	HANDLE
0 For Control Unit <u>ONLY</u> , Select This <input type="checkbox"/>	0 For Control Unit <u>ONLY</u> , Select This <input type="checkbox"/>	0 <input type="checkbox"/>
1 <input type="checkbox"/>	1 <input type="checkbox"/>	1 <input type="checkbox"/>
2 <input type="checkbox"/>	2 Vandal Resistant 1.5 gpm (5.7 L/min.) Laminar with Agion [®] Antimicrobial  <input type="checkbox"/>	2 <input type="checkbox"/>
3 <input type="checkbox"/>	3 Vandal Resistant 1.5 gpm (5.7 L/min.) Flow Control Aerator  <input type="checkbox"/>	3 152mm (6") Lever Blade Handle  <input checked="" type="checkbox"/> 
4 <input type="checkbox"/>	4 Standard 1.5 gpm (5.7 L/min.) Flow Control Aerator  <input type="checkbox"/>	4 <input type="checkbox"/>
5 <input type="checkbox"/>	5 Vandal Resistant 0.5 gpm (1.9 L/min.) Flow Control Non-Aerating Spray Outlet  <input type="checkbox"/>	5 <input type="checkbox"/>
6 Heavy Duty (R2) Rigid/Swivel Gooseneck Spout (1) (2)  <input type="checkbox"/>	6 <input type="checkbox"/>	6 <input type="checkbox"/>
7 <input type="checkbox"/>	7 Smooth End, Laminar Flow Control in Base of Gooseneck Spout 1.0 gpm (3.8 L/min.)  <input type="checkbox"/>	7 <input type="checkbox"/>
8 <input type="checkbox"/>	8 <input type="checkbox"/>	8 <input type="checkbox"/>
9 <input type="checkbox"/>	9 <input type="checkbox"/>	9 <input type="checkbox"/>

(1) **Optional Rigid/Swivel Spouts** available. (2) 120° Limited Swing Spout available. Add Suffix **-LS**.
Refer to www.specselect.com for individual models.

Flow Rates are at 60 PSI.
Note: Use this page front and back as a product submittal sheet.

Approvals:

- CSA certified
- Complies to ASME A112.18.1/CSA B125.1
- Indicates compliance to ICC/ANSI A117.1
- Outlet options 2, 3, 4 and 7 are EPA WaterSense listed
- Verified compliant with 0.25% weighted average Pb content regulations

(Contact Delta Representative for State and/or Local Approvals.)

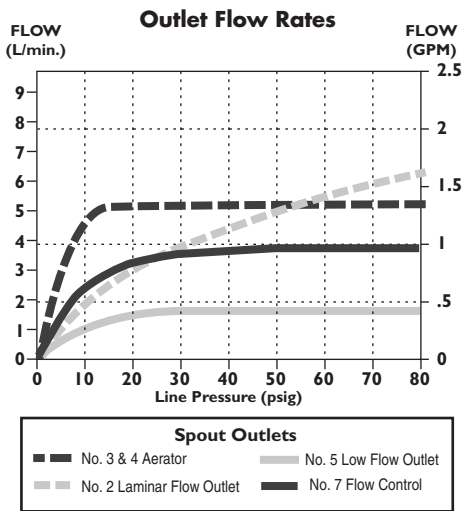
FLOW RATE vs PRESSURE

GOOSENECK SPOUT OUTLET NO.	"D"	
	mm	in.
2	18	0.45
3	11	0.45
4	11	0.45
5	11	0.45

- **24T0003**
Control Unit Only with 6" Handle

GOOSENECK

Outlets #2, 3, 4, 5

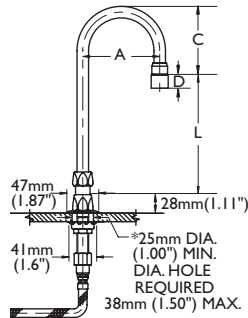

Outlet #7

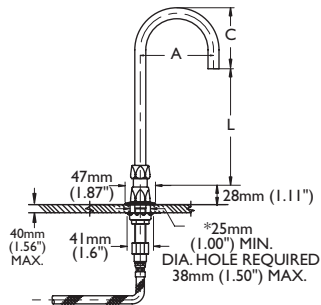
CONTROL UNIT

No. 3 Handle

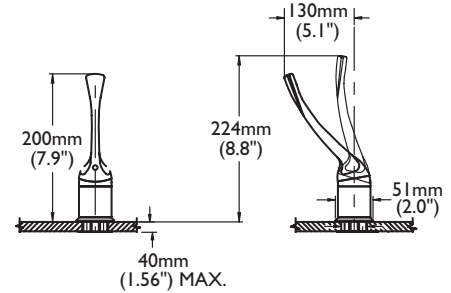

INLET FOR 3/8" OR 1/2" FLEXIBLE RISER OR 1/2-14 NPSM COUPLING NUT (NOT SUPPLIED)

LIMITED SWING GOOSENECK

- Add suffix "- LS" to Product Number for 120° Limited Swing

FOR OPTIONAL RIGID/SWIVEL & LIMITED SWING SPOUTS

See DSP-R/S for detailed specification

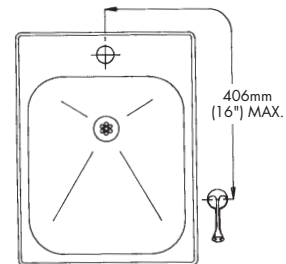
HANDICAP INSTALLATION

GOOSENECK SPOUT ASSEMBLIES

SPOUT/OUTLET	"A"		"C"		"L"	
	mm	in.	mm	in.	mm	in.
Gooseneck-Standard (R2) for outlets #2, 3, 4, 5	114	4.5	104	4.1	170	6.7
Gooseneck-Standard (R2) for outlet #7	114	4.5	97	3.8	178	7.0

Note: Measurements may vary ± 6mm (0.25")

Refer to www.specselect.com for individual models.

Note: Use this page front and back as a product submittal sheet.