

Features

- Fireclay
- Pedestal bathroom sink
- With overflow
- 8" (203 mm) centers (-8), 4" (102 mm) centers (-4), or single-hole (-1)
- 30" (762 mm) x 19-1/2" (495 mm) x 34-5/8" (879 mm)

Codes/Standards Applicable

Specified model meets or exceeds the following:

- ASME A112.19.2/CSA B45.1

PEDESTAL BATHROOM SINK K-2845

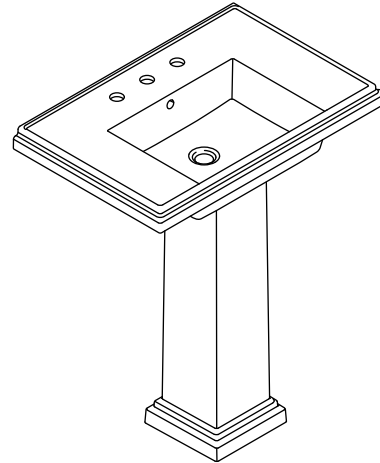

Colors/Finishes

- 0: White
- Other: Refer to Price Book for additional colors/finishes

Accessories

- CP: Polished Chrome
- Other: Refer to Price Book for additional colors/finishes

Specified Model

Model	Description	Colors/Finishes	
K-2845-1	Pedestal bathroom sink – single-hole	<input type="checkbox"/> 0	<input type="checkbox"/> Other_____
K-2845-4	Pedestal bathroom sink – 4" (102 mm) centers	<input type="checkbox"/> 0	<input type="checkbox"/> Other_____
K-2845-8	Pedestal bathroom sink – 8" (203 mm) centers (shown)	<input type="checkbox"/> 0	<input type="checkbox"/> Other_____
Recommended Accessories			
K-7605-P	Bathroom sink supplies 3/8" (pair)	<input type="checkbox"/> CP	<input type="checkbox"/> Other_____
K-8998	P-Trap	<input type="checkbox"/> CP	

Product Specification

The pedestal bathroom sink with overflow shall be made of fireclay. Bathroom sink shall be 30" (762 mm) in length, 19-1/2" (495 mm) in width, and 34-5/8" (879 mm) in height. Bathroom sink shall have single-hole (K-2845-1), 4" (102 mm) centers (K-2845-4), or 8" (203 mm) centers (K-2845-8). Pedestal bathroom sink shall be Kohler Model K-2845-_____-_____.

TRESHAM™

Technical Information

Fixture*:	
Basin area	16-3/4" (425 mm) x 12-1/2" (318 mm)
Water depth	3-1/4" (83 mm)
Drain hole	Ø 1-3/4" (44 mm)
* Approximate measurements for comparison only.	

Holes	K-2845-1	K-2845-4	K-2845-8
Spout	Ø 1-3/8" (35 mm)	Ø 1-1/4" (32 mm)	Ø 1-3/8" (35 mm)
Faucet		Ø 1-1/4" (32 mm)	Ø 1-3/8" (35 mm)

Included components:	
Bathroom sink, single-hole	K-2758-1
Bathroom sink, 4" (102 mm) centers	K-2758-4
Bathroom sink, 8" (203 mm) centers	K-2758-8
Pedestal	K-2767
Pedestal accessory pack	52204
Rubber pads	63069

Installation Notes

Install this product according to the installation guide.

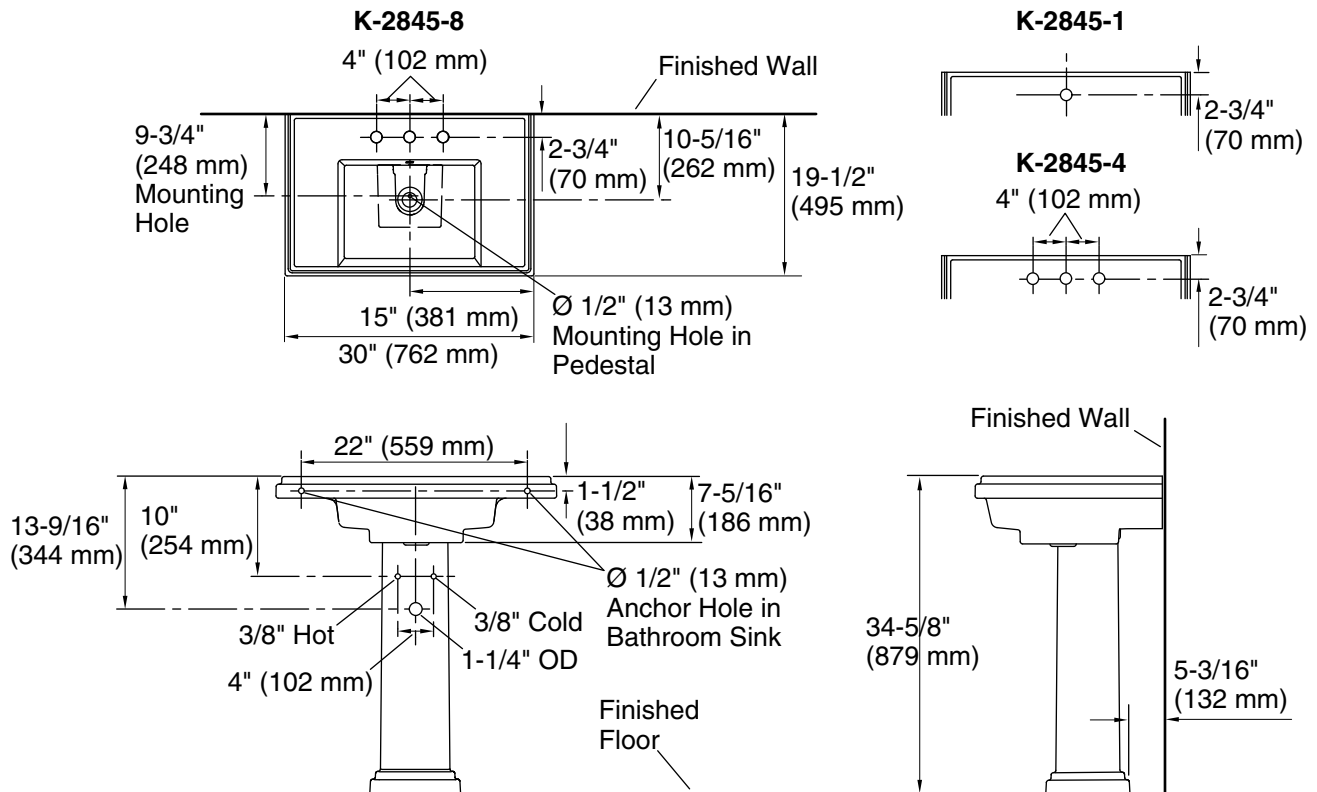

Product Diagram