

Features

- Low-profile bolt caps create a sleek, minimalistic look and simplify cleaning
- Conceals floor bolts on toilet
- Unlike standard T-bolts, no bolt cutting is required
- Caps firmly secure to washers and won't pop off
- Installation is as fast and easy as traditional bolt caps
- Offered in 10 colors, designed to match exactly with KOHLER toilets
- Clean Caps™ come standard with all KOHLER concealed toilets, including San Souci touchless (K-4000), San Souci (K-5172), Kathryn (K-3940), Portrait (K-3826), San Raphael (K-3466), Memoirs Classic (K-6999), and Memoirs Stately (K-6669)

Installation

- Three lengths of bolts are included to ensure the same range and depth as standard T-bolts
- Installation depth gauges are marked so users can easily identify which length of bolts are needed



Codes/Standards











None Applicable

KOHLER® One-Year Limited Warranty

See website for detailed warranty information.

Available Colors/Finishes

Color tiles intended for reference only.

Color	Code	Description
	0	White
	96	Biscuit
	47	Almond
	55	Innocent Blush™
	95	Ice™ Grey
	G9	Sandbar
	33	Mexican Sand™
	K4	Cashmere
	58	Thunder™ Grey
	7	Black Black™

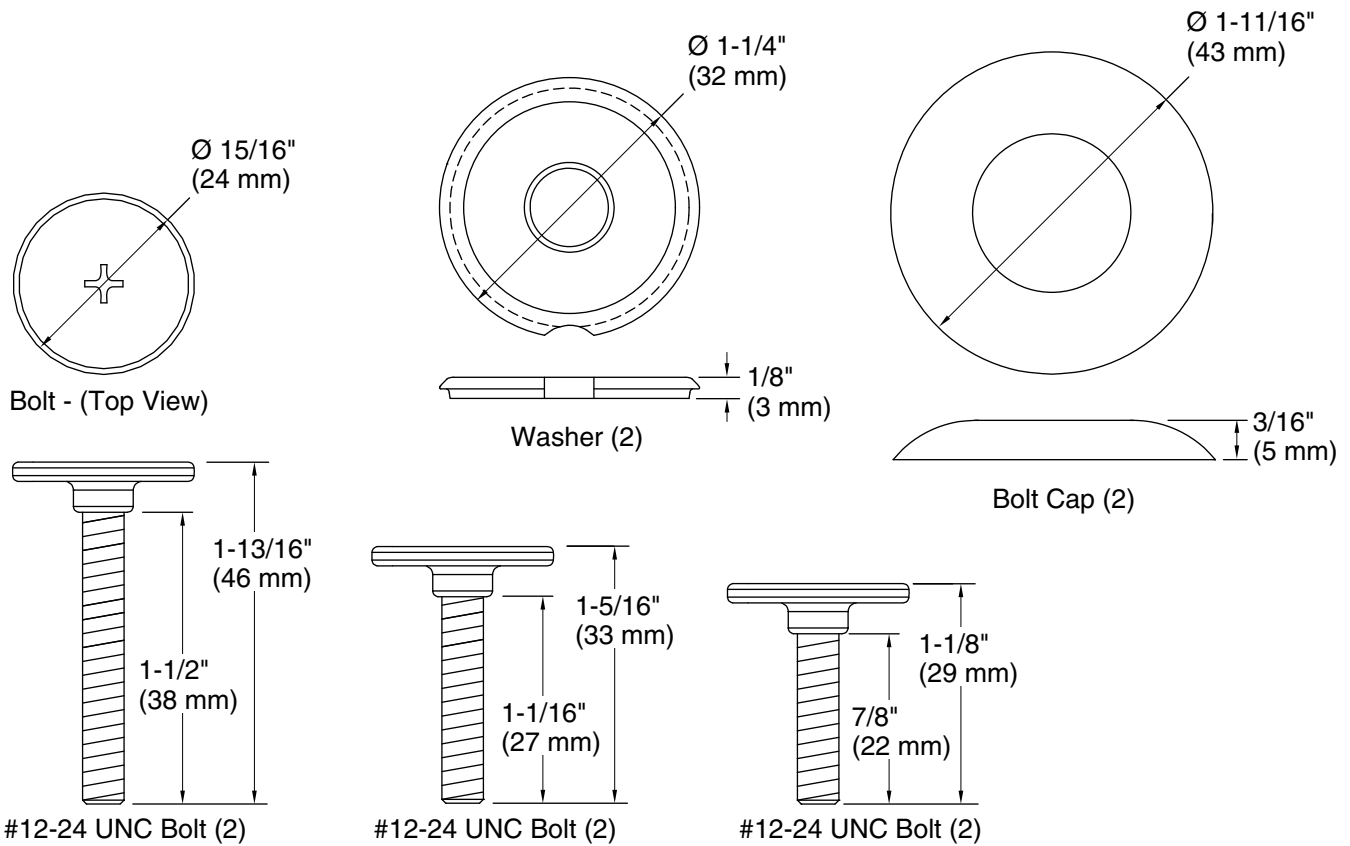

Technical Information

All product dimensions are nominal.
Material: Steel, Plastic

Notes

Install this product according to the installation guide.