



4675 W. 160th St.
Cleveland, Ohio 44135
Ph: (800) 321-9532
Fax: (800) 321-9535
www.dearbornbrass.com

SUBMITTAL SPECIFICATION

**BRASS TUBULAR
1-1/4" 90° SLIP JOINT ELBOW**

Engineering Specification: Dearborn Brass 1-1/4" Brass Tubular 90° Slip Joint Elbows are designed for use in tubular drain applications.

Job Reference

DESCRIPTION

- Chrome Finish
- 20 Gauge Brass
- 90° Slip Joint Elbow
 - Elbow
 - (2) Zinc Nuts
 - (2) Rubber Washers

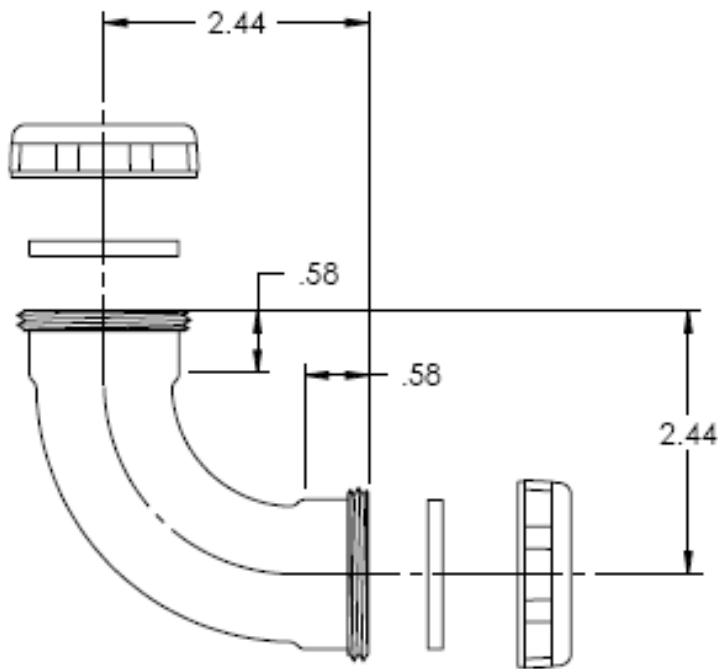
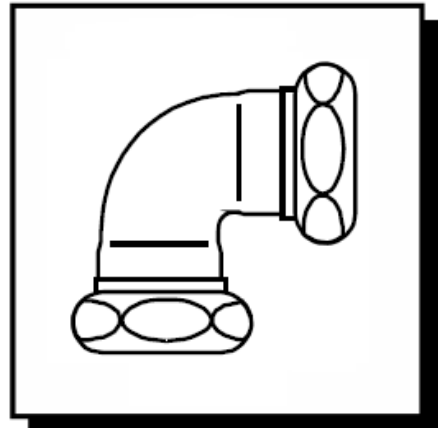

✓	Product No.	Description	Carton Quantity	Carton Weight (lbs)
	8482	1-1/4" Slip Joint 90° Elbow – 20 Gauge, Chrome	5	2

Data is subject to manufacturing tolerances.