



# Iron/Tones™

27" top-/undermount single-bowl kitchen sink  
**K-5708**

## Features

- 30" (762 mm) minimum base cabinet width
- Single bowl
- 9" (229 mm) depth provides generous workspace

## Material

- KOHLER® enameled cast iron

## Installation

- Top-mount or undermount

## Recommended Products/Accessories

- K-8801 Sink drain and strainer with tailpiece
- K-8799 Sink drain and strainer basket
- K-23726 Drain treatment
- K-23725 Cast iron cleaner

## Optional Products/Accessories

- K-8343 Sink rack for Iron/Tones® kitchen sink
- K-11352 Disposal Flange with Stopper



## Codes/Standards







ASME A112.19.1/CSA B45.2

## KOHLER® Enameled Cast Iron Kitchen and Bathroom Sink Lifetime Limited Warranty

See website for detailed warranty information.

## Available Colors/Finishes

*Color tiles intended for reference only.*

Color	Code	Description
	0	White
	FF	Sea Salt™
	96	Biscuit
	NY	Dune
	95	Ice™ Grey
	58	Thunder™ Grey
	7	Black Black™
	DGB	Indigo Blue

1-800-4KOHLER (1-800-456-4537)

Kohler Co. reserves the right to make revisions without notice to product specifications.

For the most current Specification Sheet, go to [www.kohler.com](http://www.kohler.com).

5-9-2023 02:41 - US/CA

THE BOLD LOOK  
OF **KOHLER**®

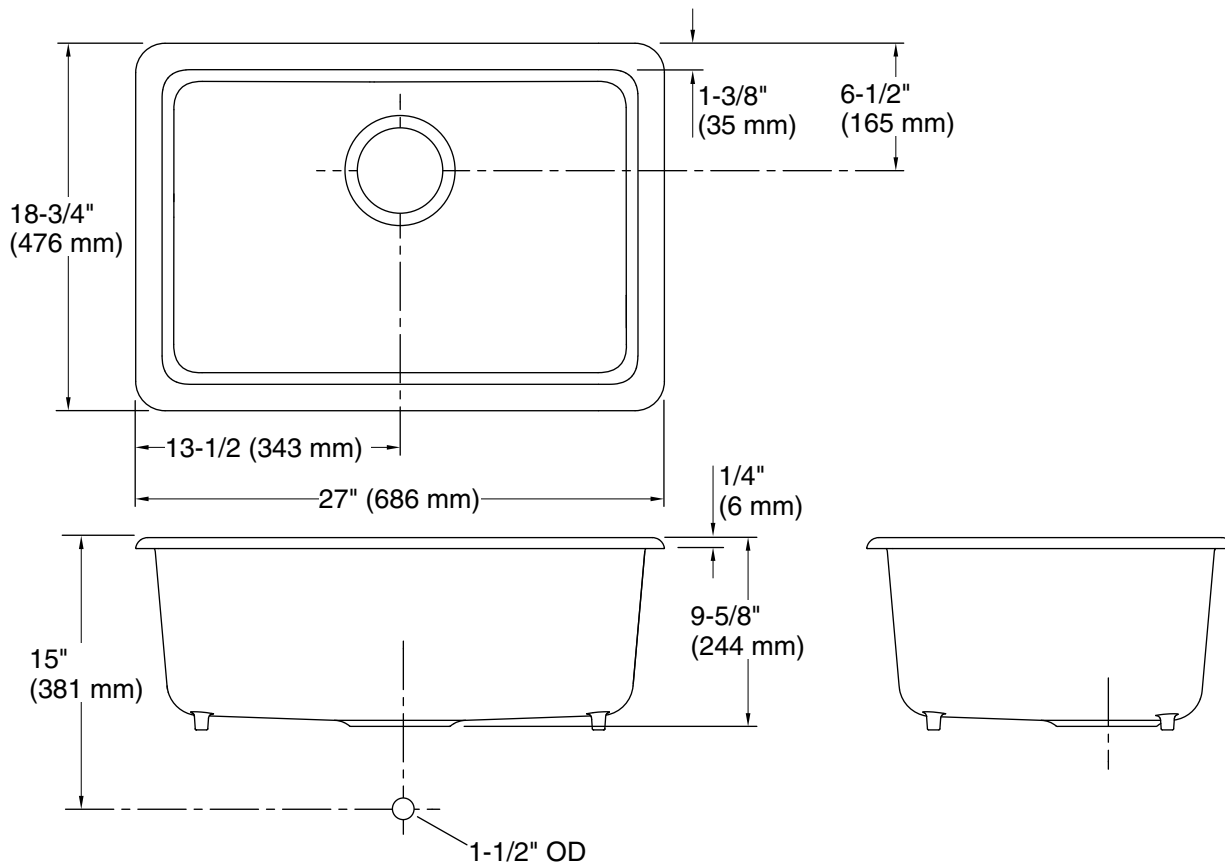

### Technical Information

All product dimensions are nominal.

Bowl configuration:	Single
Installation:	Top-mount, Undermount
Min. base cabinet width:	30" (762 mm)
Bowl area (Only):	Length: 24-5/16" (617 mm) Width: 16-1/16" (408 mm) Bowl depth: 9" (229 mm) Water depth: 9" (229 mm)
Drain hole:	3-7/8" (98 mm)
Template:	1281370-7, required, included

### Notes

Install this product according to the installation instructions.

Countertop manufacturer or cutter must use the cut-out template provided with the product, or a current one provided by Kohler Co. (call 1-800-43-FOCUS). Kohler Co. is not responsible for cut-out errors when the incorrect cut-out template is used.