

### Features

- Two-piece design.
- Elongated bowl offers added room and comfort.
- Skirted trapway simplifies cleaning.
- Revolution 360® flushing technology generates a forceful swirling motion to keep the bowl clean longer.
- Comfort Height® feature offers chair-height seating that makes sitting down and standing up easier for most adults.
- 1.28 gpf (4.8 lpf).
- 2-1/8" (54 mm) fully glazed trapway.
- Patented ReadyLock™ installation system, a simple solution for skirted toilets, saves time, hassle, and eliminates the need to drill into the floor for standard 12" (305 mm) rough-in.
- CleanCoat® surface treatment inhibits the growth of water scale and mineral stains for improved ease of cleaning.
- Alternative options available: Corbelle with ContinuousClean - K-5709
- 9-3/4" (248 mm) x 7-1/4" (184 mm) water area.

### Material

- Vitreous china.

### Technology

- Single-flush gravity uses the force of gravity and a precision-engineered tank, bowl, and trapway to create a strong siphon during flushing.
- AquaPiston® canister allows water to flow out of the tank from all sides (360°), increasing the power and effectiveness of the flush.
- Flush valve's 3:2 ratio harnesses the natural force of gravity and optimizes flush performance.
- Durable canister design has 90% less exposed seal material than a 3" flapper for leak-free performance.
- Light-touch canister flush requires a lower actuation force than a flapper.

### Installation

- Standard 12" (305 mm) rough-in.
- 10" and 14" (254 mm and 356 mm) rough-in kits also available.
- Seat and supply line sold separately.
- Floor-mount/floor outlet.

### Water Conservation & Rebates

- Eligible for consumer rebates in some municipalities.

### Recommended Products/Accessories

- K-4008 Reveal® Quiet-Close™ Elongated Toilet Seat
- K-4108 C³®-230 Elongated bidet toilet seat
- K-7637 Angle Supply with Stop (single)
- K-5383 10" Rough-in Full Skirt Trap and Attachment System



**ADA** **CSA B651** **OBC**

### Codes/Standards







ASME A112.19.2/CSA B45.1  
DOE - Energy Policy Act 1992  
EPA WaterSense®  
California Energy Commission (CEC)  
ADA  
ICC/ANSI A117.1  
CSA B651  
OBC

### KOHLER® Toilets and Seats Limited Warranty

See website for detailed warranty information.

### Available Colors/Finishes

*Color tiles intended for reference only.*

Color	Code	Description
	0	White
	96	Biscuit
	NY	Dune
	95	Ice™ Grey
	G9	Sandbar
	7	Black Black™

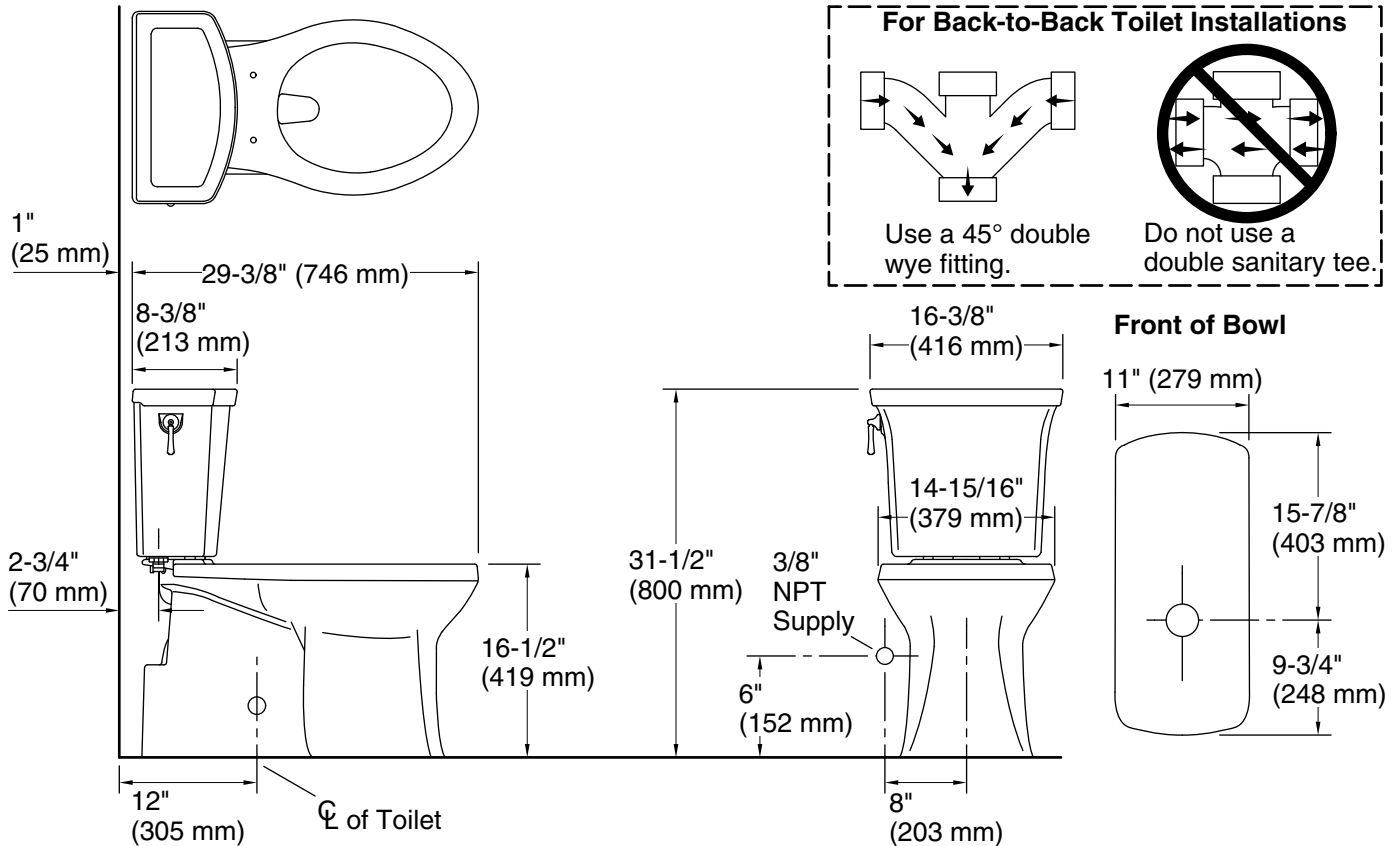

### Technical Information

All product dimensions are nominal.

Toilet type:	Two-piece, Floor-mount
Waste Outlet:	Floor
Bowl shape:	Elongated
Flush type:	Gravity siphon jet, Revolution 360®
Trap passageway:	2-1/8" (54 mm)
Water Consumption	
Full:	1.28 gpf (4.8 lpf)
Water surface size:	9-3/4" x 7-1/4" (248 mm x 184 mm)
Rim to water surface:	6-1/4" (159 mm)
Rough-in:	12" (305 mm)

### Fixture Supply Requirements

Min static pressure:	15 psi (103.4 kPa)
Max static pressure:	80 psi (551.6 kPa)

### Notes

Install this product according to the installation instructions.

For back-to-back toilet installations: Use only a 45° double wye fitting.

ADA, OBC, CSA B651 compliant when installed to the specific requirements of these regulations.

Plumbing codes may require elongated toilets and elongated, open-front seats in public bathrooms.

Accessibility standards may require controls to be located on the open side of the toilet.