

### Features

- Two lever handles offer separate control of hot and cold water
- For use with Components K-77967, K-77965, K-77968, K-77966, or K-77969 spout (sold separately)
- Coordinates with Components faucets, accessories, and showering components to complete your bathroom
- UltraGlide® valves with dry-stem technology are designed to eliminate common leak paths and provide smooth, effortless control

### Material

- Premium metal construction for durability and reliability
- KOHLER® finishes resist corrosion and tarnishing

### Installation

- For 8" - 16" (203 - 406 mm) centers
- Handles are preassembled on valves to simplify installation

### Required Products/Accessories

- K-77965 Bathroom sink faucet spout with Tube design, 1.2 gpm
- or
- K-77966 Bathroom sink faucet spout with Ribbon design, 1.2 gpm
- or
- K-77967 Bathroom sink faucet spout with Tube design, 1.2 gpm
- or
- K-77968 Bathroom sink faucet spout with Ribbon design, 1.2 gpm
- or
- K-77969 Bathroom sink faucet spout with Row design, 1.2 gpm

### Recommended Products/Accessories

- K-23887 Bathroom sink faucet spout with Row design, 1.2 gpm
- K-23723 Faucet cleaner
- K-78372 18" Towel Bar
- K-78373 24" Towel Bar
- K-78375 24" Double Towel Bar
- K-78377 Hand Towel Arm
- K-78378 Robe Hook
- K-78379 Double Towel Arm
- K-78382 Pivoting toilet paper holder
- K-78383 Vertical toilet paper holder
- K-78384 Covered double toilet paper holder

### Optional Products/Accessories



ADA CSA B651 OBC

### Codes/Standards







ASME A112.18.1/CSA B125.1  
NSF/ANSI/CAN 61  
NSF/ANSI/CAN 372  
ADA  
ICC/ANSI A117.1  
CSA B651  
OBC

### KOHLER® Faucet Lifetime Limited Warranty

See website for detailed warranty information.

### Available Colors/Finishes

*Color tiles intended for reference only.*

Color	Code	Description
	CP	Polished Chrome
	SN	Vibrant® Polished Nickel
	BN	Vibrant® Brushed Nickel
	BL	Matte Black
	2MB	Vibrant® Brushed Moderne Brass
	RGD	Vibrant Rose Gold
	TT	Vibrant Titanium

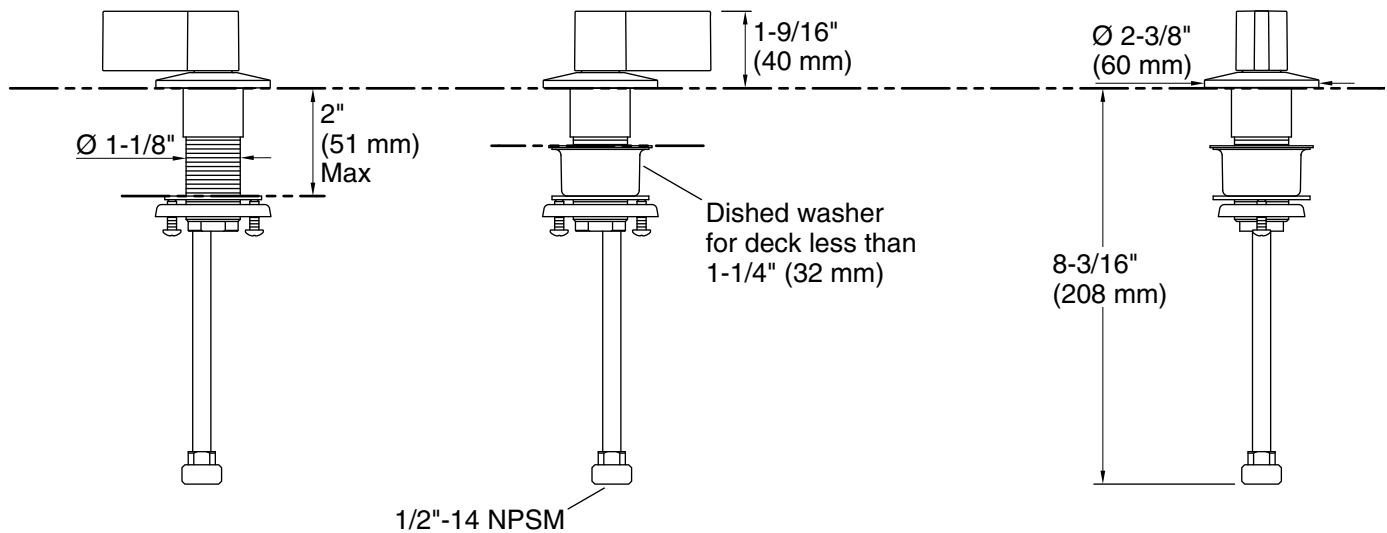

### Technical Information

All product dimensions are nominal.

Drain included: No

### Notes

Install this product according to the installation instructions.

ADA compliant for handles only.

ADA, OBC, CSA B651 compliant when installed to the specific requirements of these regulations.