



# Glen Falls™

## Top-/Under-Mount Utility Sink

### K-19017-1

#### Features

- Fits minimum 27-inch base cabinet if installed as top-mount or under-mount.
- Single bowl.
- 13-inch depth provides generous workspace.
- Single faucet hole.

#### Material

- KOHLER® enameled cast iron.

#### Installation

- Dual-mount sink can be installed as top-mount or under-mount.
- Under-mount installation kit not included.

#### Recommended Products/Accessories

K-9000 P-Trap  
K-8801 Sink Strainer  
K-8799 Sink Strainer



#### Codes/Standards









ASME A112.19.1/CSA B45.2

#### KOHLER® Enameled Cast Iron Kitchen Sink Lifetime Limited Warranty

See website for detailed warranty information.

#### Available Colors/Finishes

*Color tiles intended for reference only.*

Color	Code	Description
	0	White
	FF	Sea Salt™
	96	Biscuit
	47	Almond
	95	Ice™ Grey
	G9	Sandbar
	FT	Basalt
	7	Black Black™

1-800-4KOHLER (1-800-456-4537)

Kohler Co. reserves the right to make revisions without notice to product specifications.

For the most current Specification Sheet, go to [www.kohler.com](http://www.kohler.com).

3-18-2019 05:46 - US/CA

THE BOLD LOOK  
OF **KOHLER**®

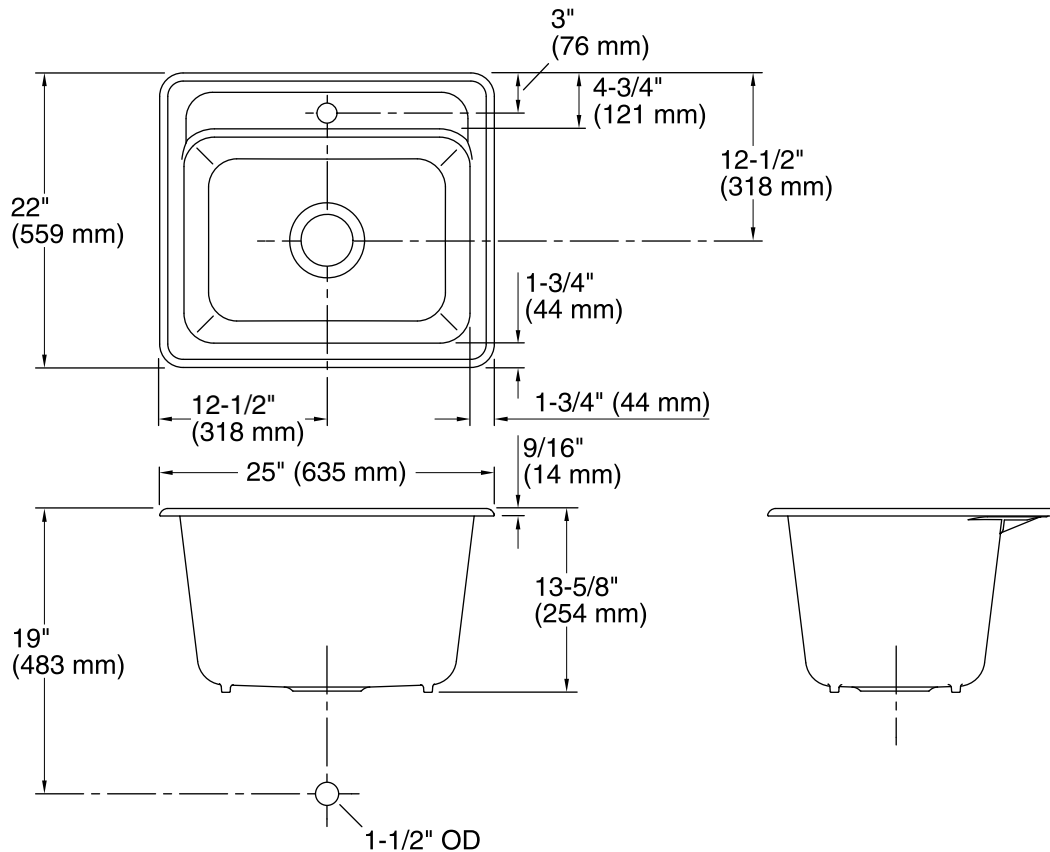

### Technical Information

All product dimensions are nominal.

Bowl configuration:	Single
Installation:	Top-mount, Under-mount
Min. base cabinet width:	27" (686 mm)
Bowl area:	Length: 21-1/2" (546 mm) Width: 15-1/2" (394 mm) Bowl depth: 13" (330 mm) Water depth: 13" (330 mm)
Number of deck holes:	1
Faucet hole(s):	1-3/8" (35 mm)
Drain hole:	3-7/8" (98 mm)
Template:	1079983-7, required, included

### Notes

Install this product according to the installation instructions.