



Underscore® Rectangle

60" x 32" Heated BubbleMassage™ air bath
K-1168-GH

Features

- 122 airjets release thousands of heated bubbles that surround, support, and massage the body.
- Variable-speed blower lets you adjust massage intensity to 18 levels.
- Built-in heater.
- Automatic and manual purge cycles remove residual water from air channels after use.
- 60-minute automatic shutoff timer.
- Slotted overflow allows for deep soaking.
- Integral lumbar support.
- Keypad control.
- Textured bottom surface.

Material

- Acrylic.

Technology

- Heated BubbleMassage™ technology warms and humidifies air before it enters the bath.

Installation

- Drop-in or undermount.
- Reversible drain.

Required Products/Accessories

K-7271 Brass Slotted Overflow Bath Drain

or

K-7272 PVC Slotted Overflow Bath Drain

Recommended Products/Accessories

- K-1491 Bath/Whirlpool Pillow
- K-1601 Bath/Whirlpool Footstop
- K-1703 Whirlpool Remote Control
- K-531 Under-Mount Installation Kit
- K-9498 3" Keypad Trim
- K-24916 Wireless Music Kit
- K-1705 Whirlpool/BubbleMassage™ Remote Control
- K-702200-G73 Frameless Sliding Bath Door
- K-702200-L Frameless Sliding Bath Door
- K-702205-L Frameless Sliding Bath Door
- K-706000-D3 Frameless Sliding Bath Door
- K-706000-L Frameless Sliding Bath Door
- K-706003-L Frameless Sliding Bath Door
- K-706004-D3 Frameless Sliding Bath Door
- K-706004-L Frameless Sliding Bath Door
- K-706007-L Frameless Sliding Bath Door
- K-1177 Vinyl Tiling-in Bead



Codes/Standards







ASME A112.19.7/CSA B45.10
CSA B45.5/IAPMO Z124
ASTM E162
ASTM E662
UL 1795
CSA C22.2 No. 218.2

**KOHLER® Hydrotherapy Components
Five-Year Limited Warranty
KOHLER® Plastic Baths and Receptors
Lifetime Limited Warranty**

See website for detailed warranty information.

Available Colors/Finishes

Color tiles intended for reference only.

Color	Code	Description
	0	White
	96	Biscuit
	NY	Dune
	95	Ice™ Grey
	58	Thunder™ Grey
	7	Black Black™

1-800-4KOHLER (1-800-456-4537)

Kohler Co. reserves the right to make revisions without notice to product specifications.

For the most current Specification Sheet, go to www.kohler.com.

9-5-2020 10:13 - US/CA

THE BOLD LOOK
OF **KOHLER**®



Underscore® Rectangle

60" x 32" Heated BubbleMassage™ air bath

K-1168-GH

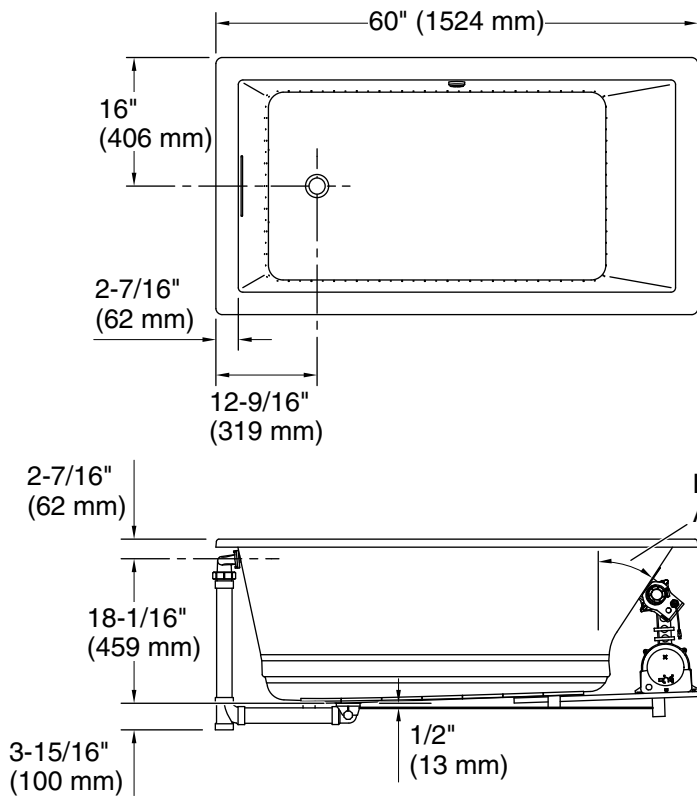

No change in measurements if connected with drain illustrated. (K-7272)

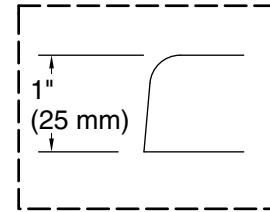

Drop-in Rim Detail

Blower Motor/Control Access
34" (864 mm) W x 15" (381 mm) H

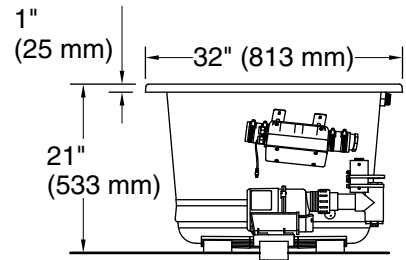

1-1/2" Bath Drain

Required Electrical Service

Two dedicated circuits required, protected with Class A Ground-Fault Circuit-Interrupter (GFCI). Outside North America, this device may be known as a Residual Current Device (RCD).

Blower: 120 V, 15 A, 60 Hz
Air bath: 120 V, 15 A, 60 Hz

Technical Information

All product dimensions are nominal.

Installation: Drop-in, Undermount
Drain location: End
Basin area, bottom: 42" x 23-1/2" (1067 mm x 597 mm)
Basin area, top: 55-1/8" x 27-1/8" (1400 mm x 689 mm)
Weight: 100 lbs (45.4 kg)
Minimum floor load: 55 lbs/ft² (268.5 kg/m²)
Water depth: 17-1/8" (435 mm)
Water capacity: 81 gal (306.6 L)
Cutout: Drop-in, 59-1/2" x 31-1/2" (1511 mm x 800 mm)
Electrical component rating: Blower: 120 V, 10 A, 60 Hz
Air bath: 120 V, 5 A, 60 Hz
Blower speed: Variable

Notes

Measure your actual product for rough-in details. Install this product according to the installation instructions.

The hot water supply should be 70% of the capacity of the bath or greater. Installations will vary.

1-800-4KOHLER (1-800-456-4537)

Kohler Co. reserves the right to make revisions without notice to product specifications.

For the most current Specification Sheet, go to www.kohler.com.

9-5-2020 10:13 - US/CA

