

### Features

- Vanity-top.
- Oval basin.
- Without overflow.
- 8-inch centers.
- Combines with standard 42" (1067 mm) x 22" (559 mm) vanities to create a complete sink.
- 43-5/8" (1108 mm) x 22-1/4" (565 mm)

### Material

- KOHLER® enameled cast iron.

### Recommended Accessories

K-9018 P-Trap



### Codes/Standards











ASME A112.19.1/CSA B45.2

### Lifetime Limited Warranty for KOHLER® Cast Iron Components

See website for detailed warranty information.

### Available Color/Finishes

*Color tiles intended for reference only.*

| Color  | Code | Description  |
|--|------|--------------|
|  | 0    | White        |
|  | FF   | Sea Salt™    |
|  | 96   | Biscuit      |
|  | 47   | Almond       |
|  | FD   | Cane Sugar™  |
|  | NY   | Dune         |
|  | 95   | Ice™ Grey    |
|  | G9   | Sandbar      |
|  | FT   | Basalt       |
|  | KA   | Black 'n Tan |
|  | 7    | Black Black™ |

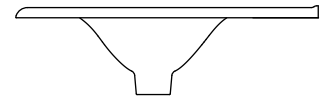
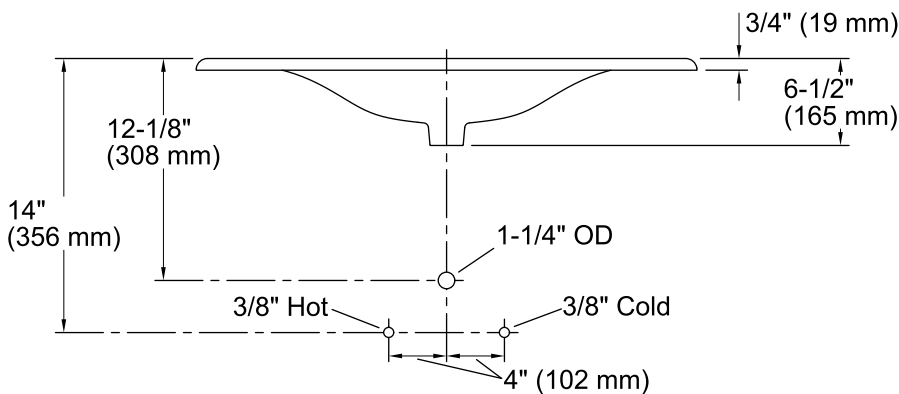
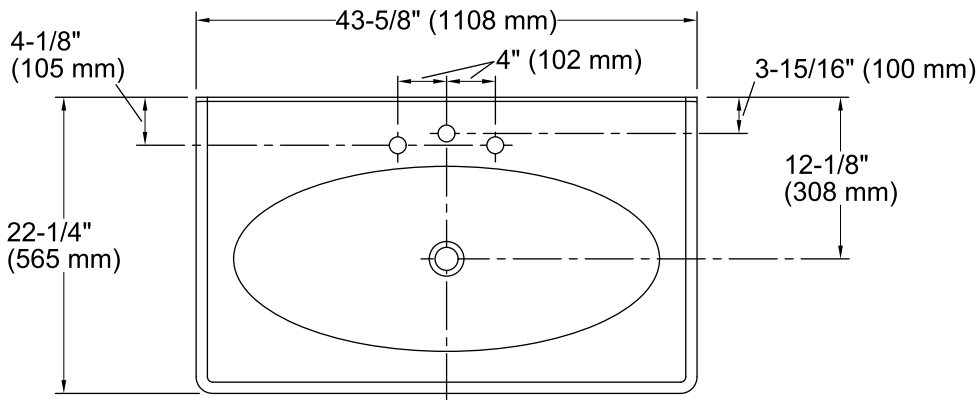

### Technical Information

All product dimensions are nominal.

|                       |   |
|-----------------------|---|
| Bowl configuration:   | Single  |
| Installation:         | ITB   |
| Bowl area (Only):     | Length: 32" (813 mm)<br>Width: 13-7/8" (352 mm)<br>Water depth: 4-1/2" (114 mm) |
| Number of deck holes: | 3   |
| Faucet hole(s):       | 1-3/8" (35 mm)  |
| Drain hole:           | 1-3/4" (44 mm)  |

### Notes

Install this product according to the installation instructions.

NOTE: When selecting a faucet for this bathroom sink, ensure the faucet has a spout reach of 4-1/2" (114 mm) to 5" (127 mm) and has a spout height of 3" (76 mm) to 6" (152 mm).

Product does not have an overflow.