

Features

- Premium metal construction for durability.
- KOHLER finishes resist corrosion and tarnish.
- For use with Archer one- and two-piece toilets.
- Coordinates with other products in the Archer Collection.



ADA	CSA B651	OBC
-----	----------	-----

Codes/Standards









ASME A112.18.1/CSA B125.1
 ADA
 ICC/ANSI A117.1
 CSA B651
 OBC

KOHLER® One-Year Limited Warranty

See website for detailed warranty information.

Available Color/Finishes

Color tiles intended for reference only.

Color	Code	Description
	SN	Vibrant® Polished Nickel
	AF	Vibrant® French Gold
	PB	Vibrant® Polished Brass
	G	Brushed Chrome
	BN	Vibrant® Brushed Nickel
	BV	Vibrant® Brushed Bronze
	2BZ	Oil-Rubbed Bronze
	RGD	Vibrant Rose Gold
	VNT	Vintage Nickel

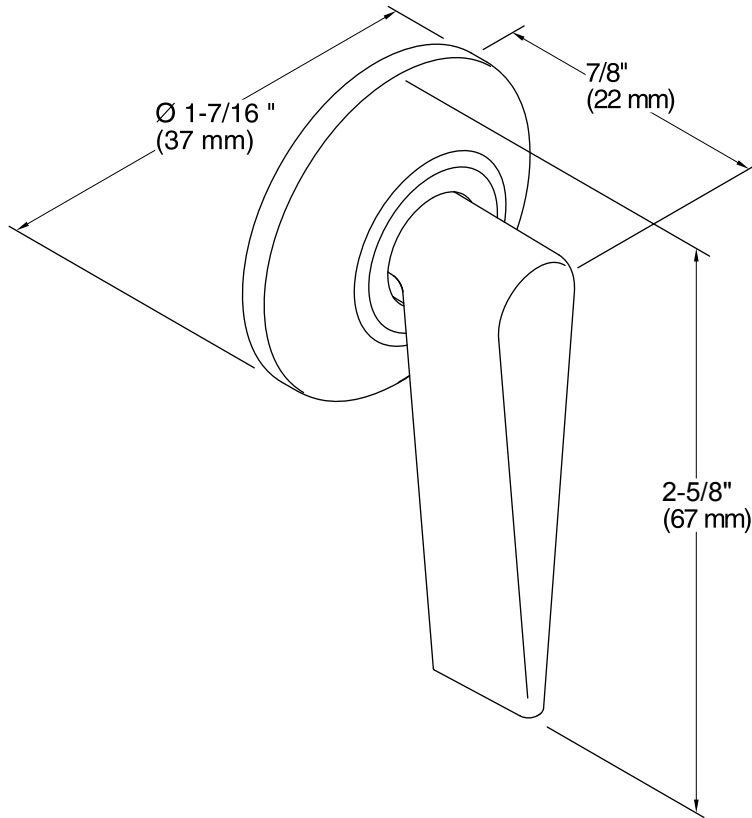

Technical Information

All product dimensions are nominal.

Notes

ADA, OBC, CSA B651 compliant when installed to the specific requirements of these regulations.