

Submitted Model No.: _____
 Specific Features: _____

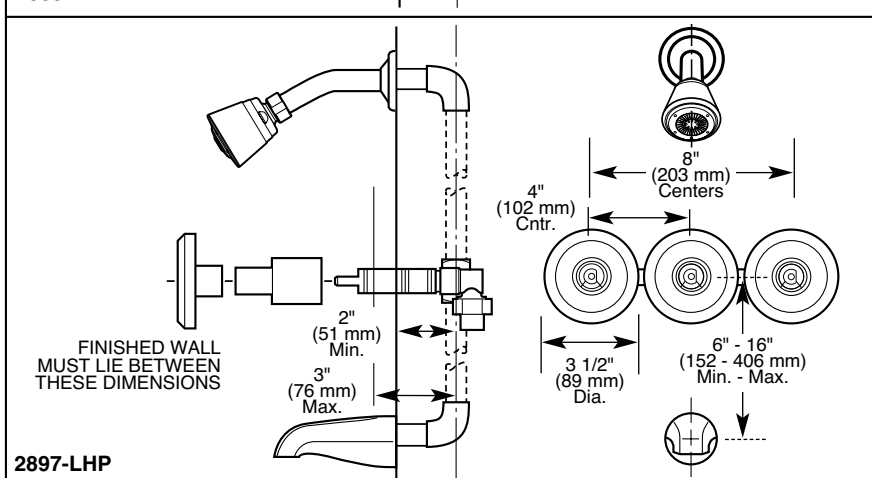

BATH VALVES

- Valve Only (2653 Series)
- Tub/Shower (2683/2885/2897 Series)
- Three Handle
- 8" (203mm) Rigid Valve
- Temperature and Volume Controlled with Handles

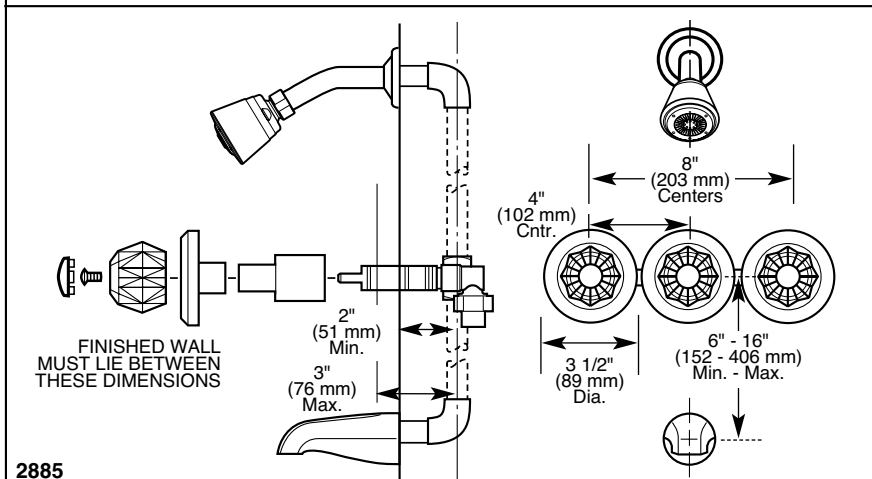
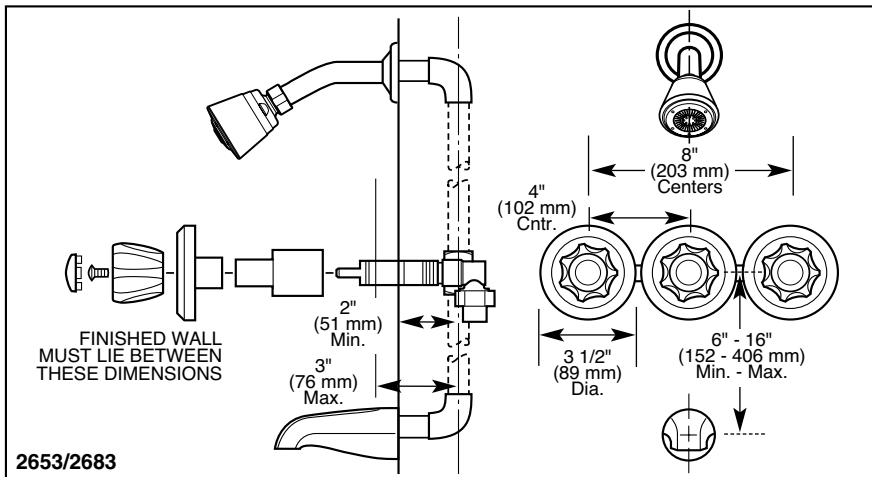

LISTED
 UL Listed to US and Canadian
 Safety Standards
 21EL



COMPLIES WITH:

- ASME A112.18.1M-1996
- CSA B125-93
- Indicates ADA compliance to CABO/ANSI A117.1-1992
- Showerhead GSA A-A-240
- CSA Certified
- IAPMO Listed





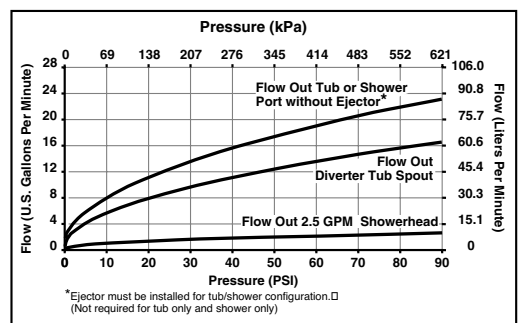



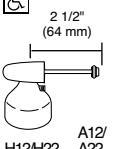
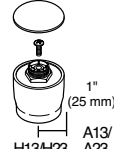
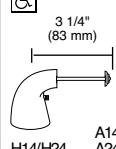
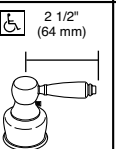
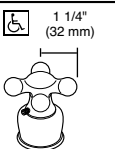

STANDARD SPECIFICATIONS:

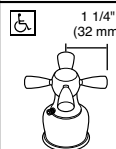
- Two handle valve type with rigid one-piece brass body.
- Diverter handle.
- Positive shut-off diverter.
- 8" (203 mm) rigid valve.
- Requires 2" (51 mm) wall cavity.
- Can be installed with floor or ceiling supplies.
- Clear knob handles with red/blue indicators or LHP – Less Handle Program. See available handle options on back.
- Screw-on escutcheons.
- Control mechanism shall be of the rotating cylinder type with stainless steel plate and 180° rotation, with replaceable non-metallic seats operating in stainless steel lined sockets.
- Hot and cold stems are interchangeable.
- Temperature and volume controlled with handles.
- All operating parts shall be replaceable from the front.
- Models **with** suffix "C" supplied with 1/2" C.W.T. sweat inlets and 1/2" iron pipe outlets.
- Models **without** suffix "C" inlets are supplied with universal fittings to accept 1/2" copper or iron pipe and 1/2" iron pipe outlets.



| Standard Features | 2653 | 2653-C | 2683 | 2683-C | 2885-PB | 2897-CBLHP | 2897-LHP | 2897-PBLHP |
|--|------|--------|------|--------|---------|------------|----------|------------|
| Washerless | ◆ | ◆ | ◆ | ◆ | ◆ | ◆ | ◆ | ◆ |
| Can be Installed with Floor or Ceiling Supplies | ◆ | ◆ | ◆ | ◆ | ◆ | ◆ | ◆ | ◆ |
| 1/2" C.W.T. Sweat Inlets and 1/2" Iron Pipe Outlets | | ◆ | | ◆ | | | | |
| Inlet Universal Fittings—Accepts 1/2" Copper or Iron Pipe and 1/2" Iron Pipe Outlets | ◆ | | ◆ | | ◆ | ◆ | ◆ | ◆ |
| Replaceable Stems | ◆ | ◆ | ◆ | ◆ | ◆ | ◆ | ◆ | ◆ |
| Clear Knob Handles with Red/Blue Indicators (H11/H21) | ◆ | ◆ | ◆ | | | | | |
| Clear Knob Handles with Red/Blue Indicators (H31/H41) | | | | | ◆ | | | |
| Less Handle Program—See Handle Kit Option* | | | | | | ◆ | ◆ | ◆ |
| Screw-On Escutcheons | ◆ | ◆ | ◆ | ◆ | | | | |
| Decorative Screw-On Escutcheons | | | | | ◆ | ◆ | ◆ | ◆ |
| Positive Shut-Off Diverter | ◆ | ◆ | ◆ | ◆ | ◆ | ◆ | ◆ | ◆ |
| Metal Shower Arm and Flange | | | | ◆ | ◆ | ◆ | ◆ | ◆ |
| Non-Metallic Push-Clean™ Showerhead/1 Spray Pattern (RP28599) | | | | ◆ | ◆ | ◆ | ◆ | ◆ |
| Metal Over-the-Rim Tub Filler (RP5833) | | | | ◆ | ◆ | ◆ | ◆ | ◆ |
| Chrome Finish | ◆ | ◆ | ◆ | ◆ | | | ◆ | |
| Chrome and <i>Brilliance</i> ™ Polished Brass Finish | | | | | | ◆ | | |
| <i>Brilliance</i> ™ Polished Brass Finish | | | | | ◆ | | | ◆ |

*Available LHP Handle/Accent Options

| | | | |
|---|--|--|--|
|  H11/H21 |  H12/H22 |  H13/H23 |  H14/H24 |
|  H15/H25 |  H17/H27 |  H31/H41 |  H36/H46 |
|  | A22CL |  | A24CL |
|  | A22, A22AL, A22PB, A22PR, A22WH |  | A24, A24AL, A24PB, A24WH |
|  | A22OK, A22RS, A22WW |  | A23ST |
|  | A23, A23AL, A23PB, A23WH |  | A23OK |

Available Options for Field Conversion:

- NOTE—Screwdriver Stops are included on valves with "WS" suffix. Stops cannot be added in field on these models.
- Shower Arm. Order RP6023▲.
- Shower Flange. Order RP6025▲.
- Non-metallic Touch-Clean® showerhead/1 spray pattern. Order RP28600▲.
- Non-metallic Dual Spray Touch-Clean® showerhead/2 spray patterns. Order RP28601▲.
- Non-metallic Ultimate Touch-Clean® showerhead/3 spray patterns. Order RP28602▲.
- Brass shower arm diverter for hand shower. Order RP4239 (chrome only).
- Personal hand shower with 24" (610 mm) vertical bar, 60" (1524 mm) hose. Order RPW1111HDF (chrome only).
- Personal hand shower with 24" (610 mm) vertical bar, 60" (1524 mm) hose, vacuum breaker and wall supply elbow. Order RPW2222HDF (chrome only).
- Metallic over-the-rim slip-on tub filler for 1/2" C.W.T. Order RP5835 (chrome only).
- Bath waste assemblies and bath accessories also available separately.

Installation Aids:

- Thin wall mounting spacer kit—mounts valve directly to wall—accommodates 1/8" (3 mm) to 1 1/8" (29 mm) thick wall. Order RP18187 or RP18724 (bulk).
- Extension kit—extends rough-in depth by 1" (25 mm). Order RP19156▲.

▲ Designate proper finish suffix.

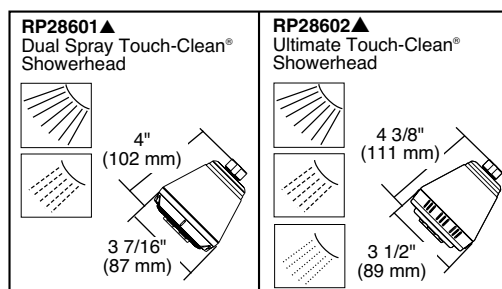
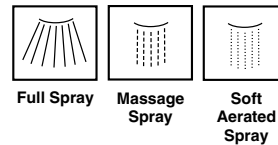
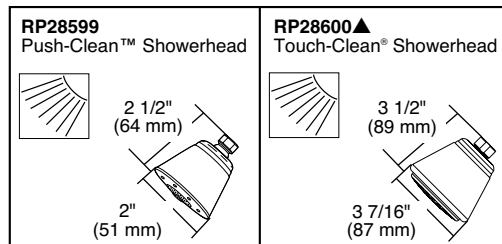
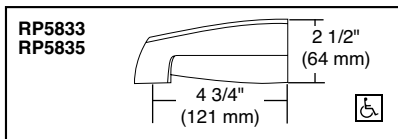

Indianapolis, Indiana 46280
A Division of Masco Corporation of Indiana
© 2001 Masco Corporation of Indiana