

Features

- Modular Cabinet - build arrays with lighting and cabinets to suit
- Quiet close Safeseal® Gasket
- Mirrored interior with 4 adjustable glass shelves
- Includes installation hardware for recess mounting
- Can be recessed or surface mounted (surface mounting kit required)
- Electric Option Cabinet:
 - Standard knock out for 1/2" (13 mm) cable connector
 - Wired internally - Front access serviceability

Construction

- Rust free aluminum construction
- Finished in Satin anodized aluminum, or White or Black finish
- 3 mirror design - rear of cabinet and both sides of door
- Blum 170° self-closing hinges
- Safeseal® Gasket with sealed corners on cabinet body
- Adjustable shelving at 2" (51 mm) increments

Codes/Standards Applicable

- Electric Option Models are ETL certified to:
 - UL 962
 - CSA Standard C22.2 No. 68

Dimensions

Height: 39-3/8" (1000 mm)
 Width: 19-1/4" (489 mm)
 Depth: 4-5/8" (117 mm) When surface mounted
 7/8" (22 mm) When recessed

Options

- Left or Right hand hinged
- Polished edge or beveled front mirror
- Flat front mirror
- Electric, 120VAC outlet
- Other widths / heights available

Installation Options

Recessed Mount - Rough Opening - 38-5/8" H x 18-1/2" W x 4" D (981 mm H x 470 mm W x 102 mm D)

Surface Mount - Reference Surface Mount Kit when ordering PLSMK40D4P - Mirror Kit

Gangs to PLM Series Cabinet - Reference PL Ganging Kit when ordering - PLGKIT

Gangs to Lighting - Reference Ganging kit for the particular light option when ordering

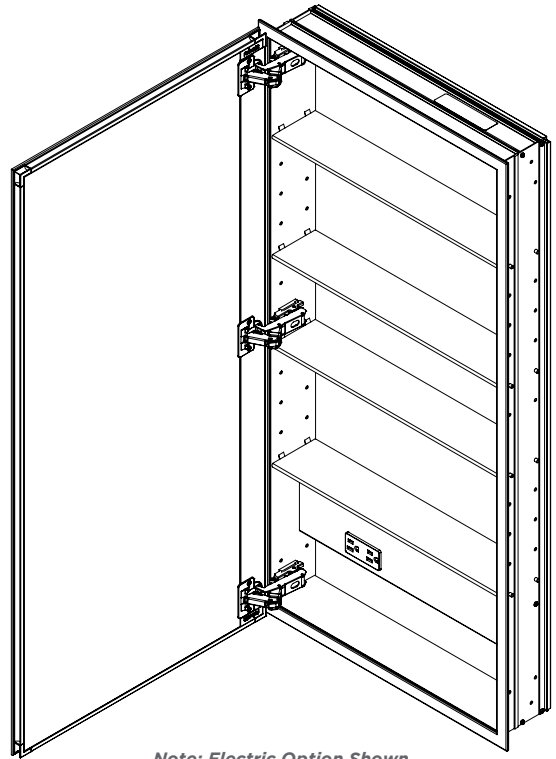

Note: Electric Option Shown

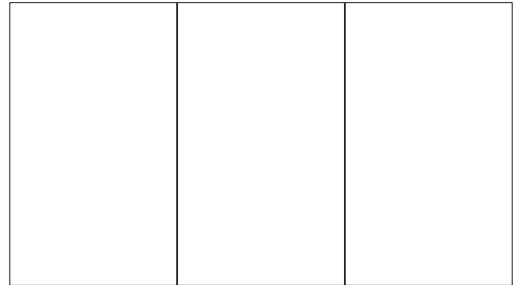

Ganging Cabinet-to-Cabinet Arrangement

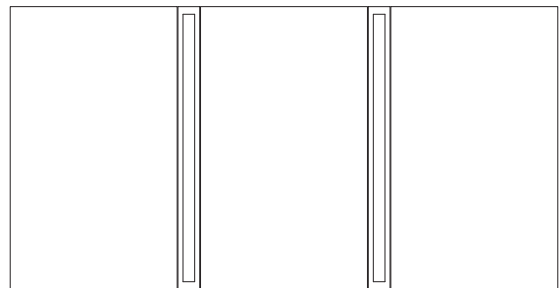

Ganging Cabinet-to-Lights Arrangement

Model Number Key

PLM Series	Width	Height	Interior Color	Mirror Edge Style	Hinge Side
PLM	20	40	B = Black G = Classic Grey W = White	[Blank] = Polished B = Beveled	[Blank] = Non-Handed LE = Left Electric RE = Right Electric

Electrical System

- 120 VAC 60HZ 20A
- Field wire location as shown in drawing
- 1/2" conduit (Ø 7/8" actual) electrical knockout location shown below

Optional Accessories

- Assorted glass bins:
 - Small (GLASSBIN3.25)
 - Medium (GLASSBIN5.25)
 - Large (GLASSBIN8.5)
- Handle Kits - MHANDLEKIT
- Pull-out Magnifying Mirror - POMM
- Push-to-open Kit - MPUSHKIT
- Safety Lock Box - SLB20D4
- Swing out Magnifying Mirror - SOMM

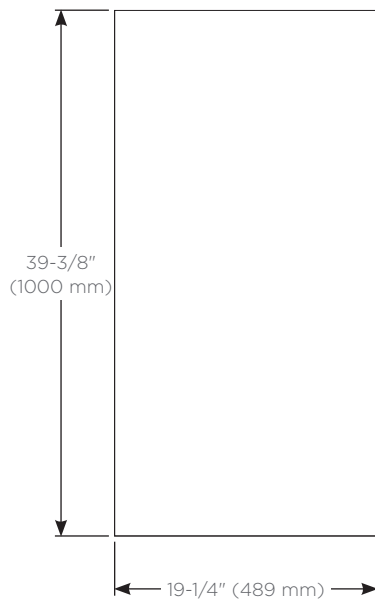
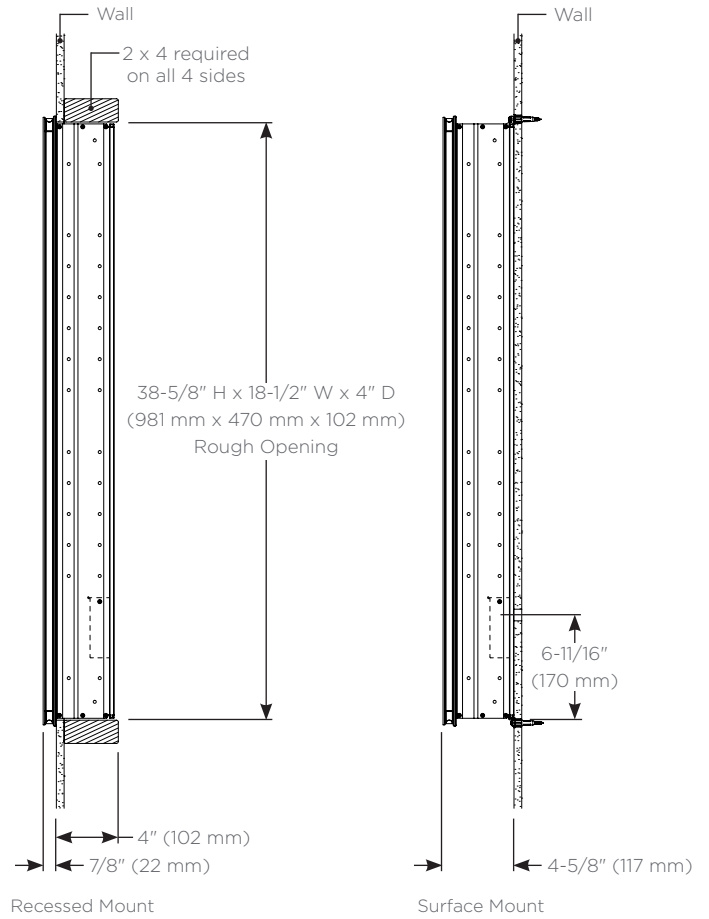

Cabinet Dimensions

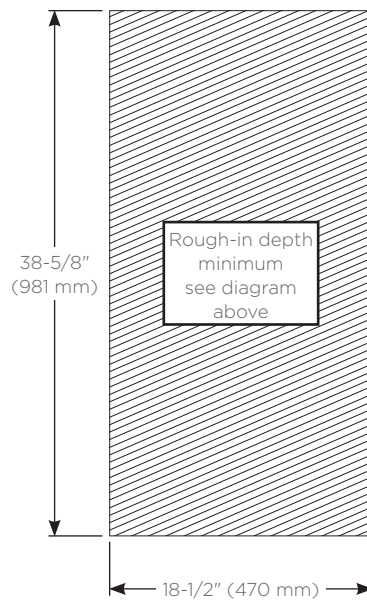

Rough-in Dimensions

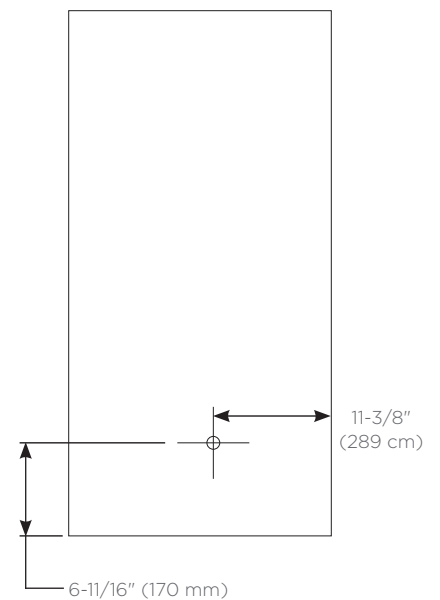

Back of Cabinet - Wire Access Location