

## Features

- Fits minimum 36" (914 mm) apron sink base cabinet.
- 9-1/2" depth provides generous workspace.
- Matte finish offers rich, dimensional color.
- Solid color throughout the sink.
- Scratch, stain, chip, and thermal-shock resistant.
- Offset drain increases workspace in the sink and storage space underneath.
- Self-Trimming® apron overlaps cabinet face for easy installation and beautiful results.

## Material

- KOHLER Neoroc® composite is durable and built to withstand day-to-day cleaning tasks.
- Heat-resistant up to 750°F.

## Installation

- Undermount.

## Recommended Products/Accessories

- K-8801 Sink drain and strainer with tailpiece
- K-8799 Sink drain and strainer basket

## Optional Products/Accessories

- K-11352 Disposal Flange with Stopper
- K-9000 P-Trap

## Included Components

- Additional Components:
- 26026
  - 30182



## Codes/Standards









CSA B45.5/IAPMO Z124

## KOHLER® Neoroc® Sinks Lifetime Limited Warranty

See website for detailed warranty information.

## Available Colors/Finishes

*Color tiles intended for reference only.*

Color	Code	Description
	CM6	Matte White
	CM7	Matte Graphite
	CM5	Matte Beige
	CM8	Matte Black Plum
	CM1	Matte Black
	CM2	Matte Brown
	CM3	Matte Taupe
	CM4	Matte Grey

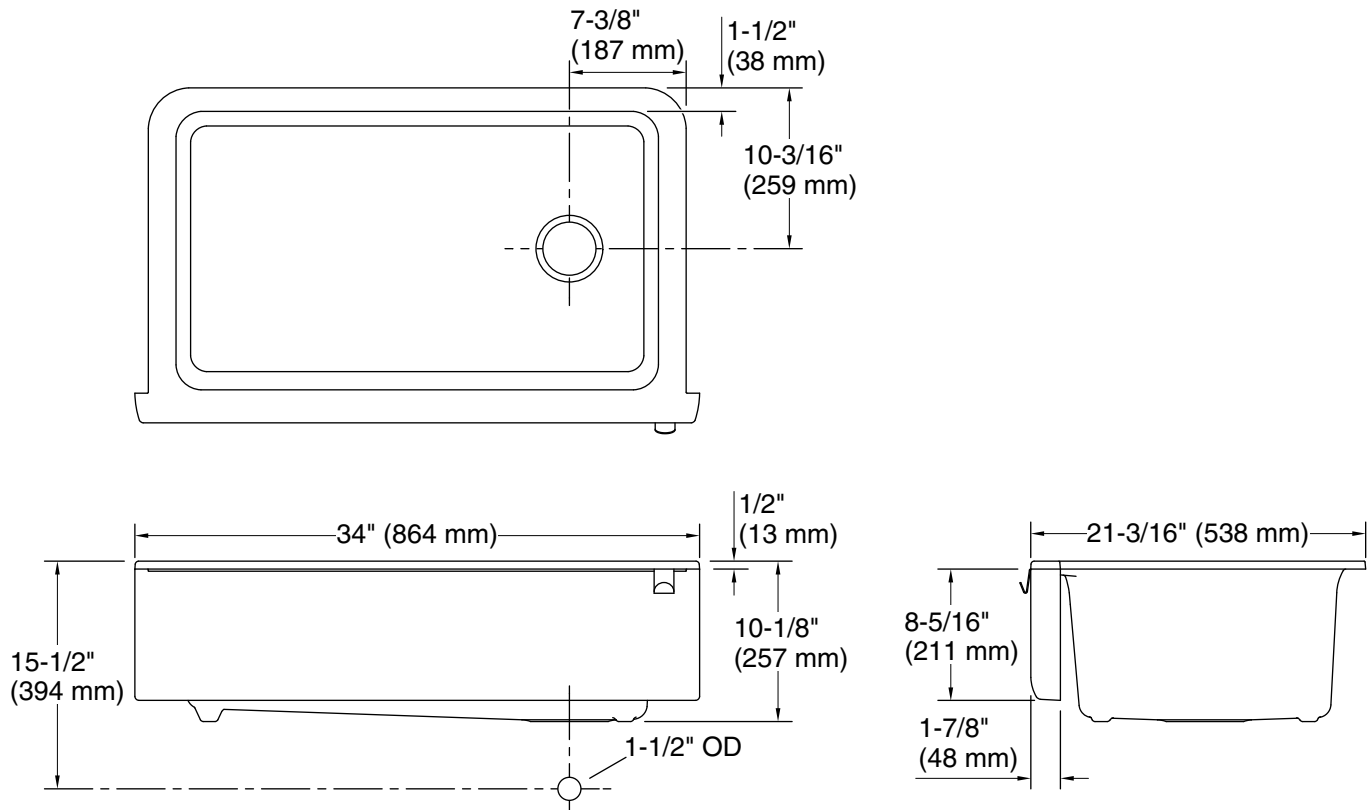

## Technical Information

All product dimensions are nominal.

Bowl configuration:	Single
Installation:	Undermount
Min. base cabinet width:	36" (914 mm)
Bowl area (Only):	Length: 28-5/8" (726 mm) Width: 15-1/2" (394 mm) Bowl depth: 9-1/2" (241 mm) Water depth: 9-1/2" (241 mm)
Drain hole:	3-7/8" (98 mm)
Template:	Apron-front, 1400299-7, required, included

## Notes

Install this product according to the installation instructions.