

## Features

- Minimum 27-inch base cabinet width.
- Single bowl.
- 9-1/2-inch depth provides generous workspace.
- No faucet holes.
- Includes K-80037 bottom sink rack.
- Includes cutout templates and installation clips.

## Material

- KOHLER Neoroc® composite is durable and built to withstand day-to-day cleaning tasks.
- Matte finish offers rich, dimensional color.
- Solid color throughout the sink.
- Heat resistant up to 750°F.
- Scratch, stain, chip, and thermal-shock resistant.

## Installation

- Undermount.
- Easy to install in a one-person, single-day project.

## Recommended Products/Accessories

K-8801 Sink Strainer  
K-8799 Sink Strainer  
K-23726 Drain treatment  
K-23730 Neoroc® cleaner

## Optional Products/Accessories

K-11352 Disposal Flange with Stopper  
K-9000 P-Trap

## Included Components

Product consists of:  
K-80037 Sink Rack



## Codes/Standards









CSA B45.5/IAPMO Z124

## KOHLER® Neoroc® Sinks Lifetime Limited Warranty

See website for detailed warranty information.

## Available Colors/Finishes

*Color tiles intended for reference only.*

Color	Code	Description
	CM6	Matte White
	CM7	Matte Graphite
	CM5	Matte Beige
	CM8	Matte Black Plum
	CM1	Matte Black
	CM2	Matte Brown
	CM3	Matte Taupe
	CM4	Matte Grey

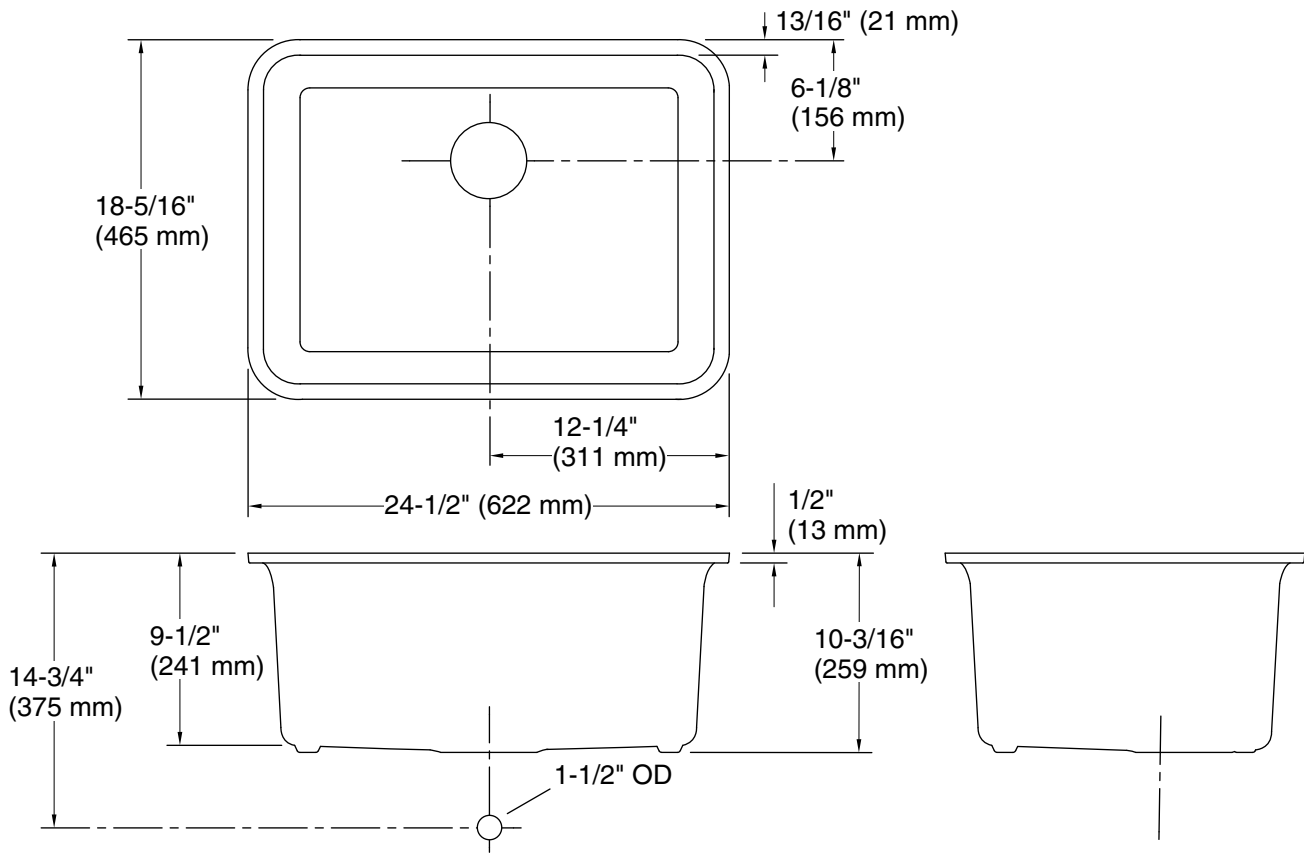

## Technical Information

All product dimensions are nominal.

Min. base cabinet width: 27" (686 mm)

Bowl area (Only):  
 Length: 22-9/16" (573 mm)  
 Width: 16-3/8" (416 mm)  
 Bowl depth: 9-1/2" (241 mm)  
 Water depth: 9-1/2" (241 mm)

Template: 1316451-7, required, included

## Notes

Install this product according to the installation instructions.

Countertop manufacturer or cutter must use the cut-out template provided with the product, or a current one provided by Kohler Co. (call 1-800-43-FOCUS). Kohler Co. is not responsible for cut-out errors when the incorrect cut-out template is used.