

Rubix 6030 Acrylic Alcove Bathtub

Model number:

105815-000-001-001

Dimensions: 59.75" x 30" x 18.375"

Installation: Alcove

Material: Acrylic

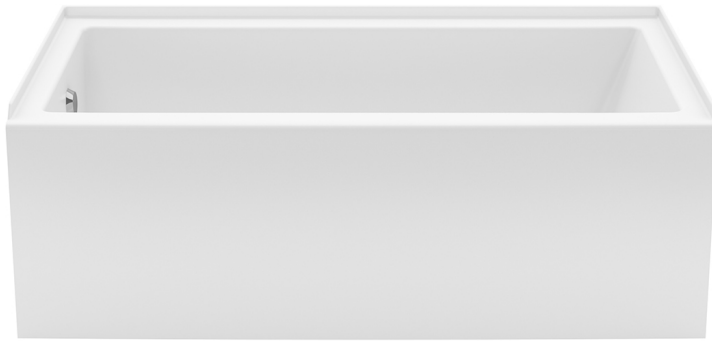

Standard Features:

- Rectangular shape bathtub in alcove installation
- Available in Above-the-Floor Rough (AFR) or not
- Right or left-hand drain
- Cubic design
- Integrated flat skirt and tiling flange

Product characteristics:

- Made in North America
- Integrated Tiling Flange and Skirt
- Utile Compatible

Standard Colors:



White



Bone



Biscuit

Certifications

MAAX products adhere to one or more of the following certifications:



MAAX

Rubix 6030 Acrylic Alcove Bathtub

Model number:

105815-000-001-001

Dimensions: 59.75" x 30" x 18.375"

Installation: Alcove

Material: Acrylic

Dimensions

59 3/4 x 30 x 18 1/2 In.
(1518 x 762 x 467 mm)

Water Capacity

54 gallons - 205 liters

Weight

77 lbs - 35 kg

Bathing Well

54 3/4 In. x 23 1/2 In.
(1391 mm x 594 mm)

Deep Sump Height

16.75 In. - 425 mm

Deck Width

3.125 In. - 79 mm

Drain location:

Left

Right

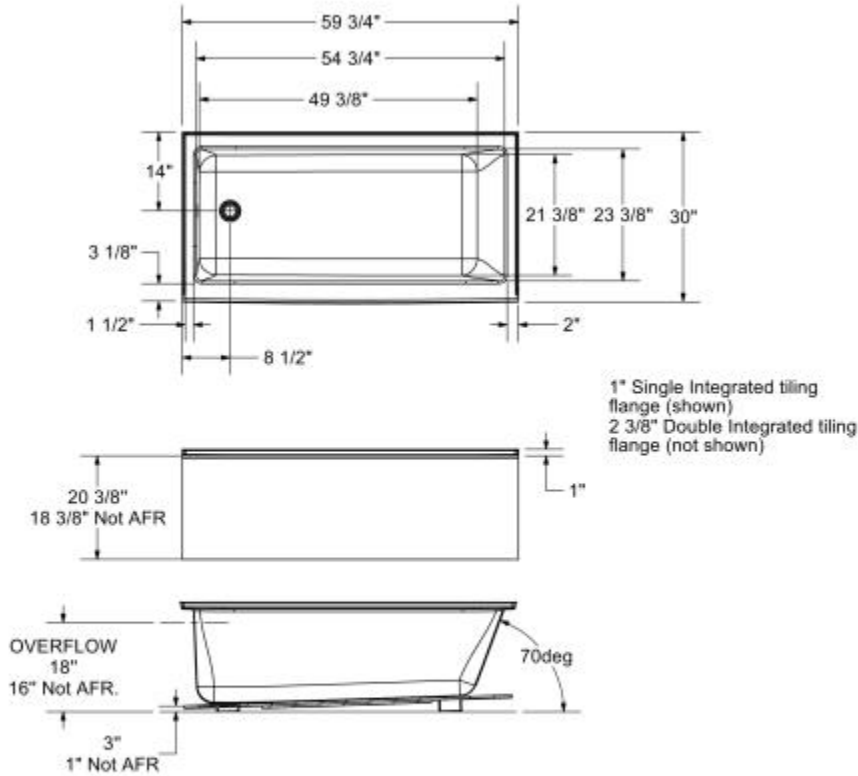

Wood support design may vary.
Single integrated tiling flange: 1" height x 1/4" thickness (shown)
Double integrated tiling flange: 2 3/8" height (not shown)
All dimensions are approximate. Structure measurements must be verified against the unit to ensure proper fit.

Project:

Contractor:

Representative:

Date:

Tel:

Notes:

MAAX