

PP1

pumpout port kit

For Use with Grease Interceptors

Models GB1, GB2 and GB3

Specification

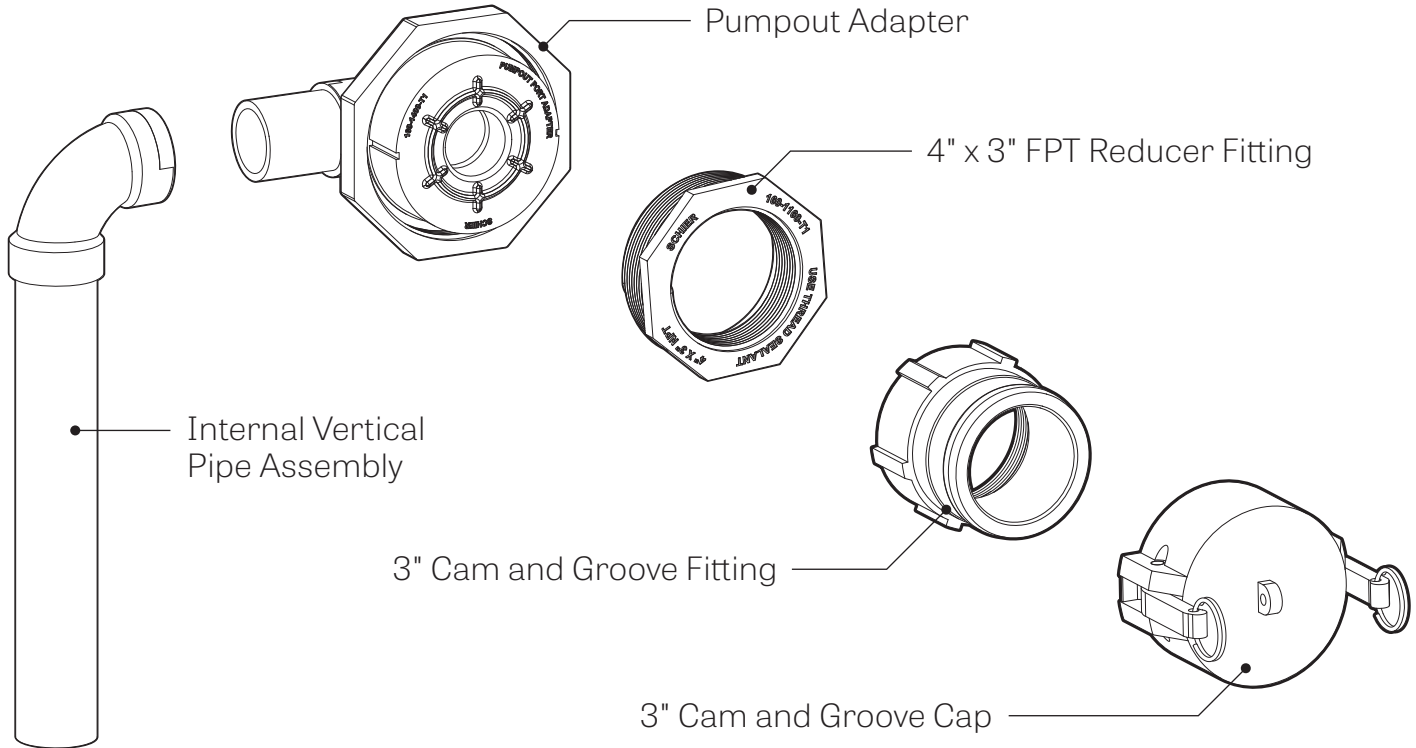

Notes

1. Additional plumbing fitting(s) required to complete kit installation. Fitting(s) determined by unit outlet configuration.
2. Unit weight: 5 lbs.

Engineer Specification Guide:

Pumpout port kit to consist of internal PVC SCH. 40 1-1/2" piping, injection molded PVC SCH. 40 internal fitting adapter, injection molded polypropylene retaining nut and 4" x 3" FPT reducer fitting and standard 3" cam and groove fitting (for pumper hook-up).

Installation Notes

1. Maximum vertical distance from static water line of grease interceptor to pumpout port hook-up shall not exceed 21 feet.
2. Maximum horizontal distance from grease interceptor to pumpout truck (including pumper hose) shall not exceed 100 feet.
3. Plumbing from interceptor to hook-up to have a maximum quantity of 6 elbow fittings.



SCHIER
LIFETIME GUARANTEED
GREASE INTERCEPTORS

MODEL NUMBER:
PP1

DESCRIPTION: Pumpout Port Kit

PART #: 8400-011-02

DWG BY: B. Karrer

DATE: 5/16/2018

REV: 2 8/01/2017

ECO:



SPECIAL PRECAUTIONS

For All Schier Grease Interceptor Installations - Failure to follow this guidance voids your warranty

Installation Instructions

Installation instructions and additional components are included with the interceptor. Read all instructions prior to installation. This interceptor is intended to be installed by a licensed plumber in conformance with all local codes.

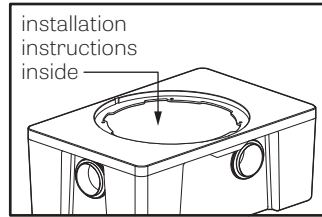

When Installing Interceptor Inside

If your dishwashing sink(s) discharges into a floor drain/sink (drain), you must regulate the flow into the drain to avoid an overflow of water onto the kitchen floor. This can be done by installing a valve or flow restriction cap on the sink piping that discharges into the drain. See drawing above for guidance. For detailed guidance on indirect connections, go to:

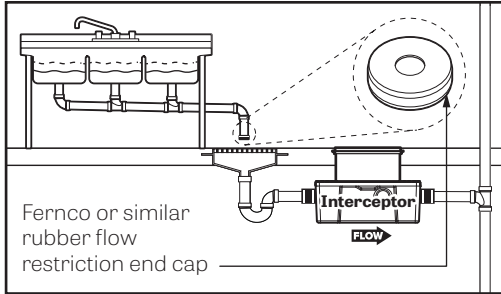

http://webtools.schierproducts.com/Technical_Data/Indirect_Connections.pdf

Flush-to-Grade Burials

Flush-to-Grade buried installations (without a riser) are not recommended for heavy foot traffic areas without the use of an internal support system (sold additionally).

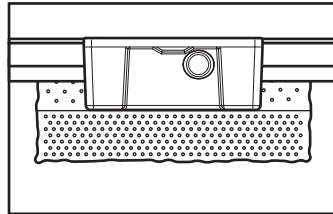

High Temperature Kitchen Water

If water is entering the interceptor at excessive temperature (over 140° F), a drain water tempering valve (DTV) and approved backflow prevention assembly must be installed. Most state and local plumbing codes prohibit water above 140° F being discharged into the sanitary sewer. Water above 140° F will weaken or deform PVC Schedule 40 pipe, poly drainage fixtures like interceptors and erode the coating of cast iron (leading to eventual failure).

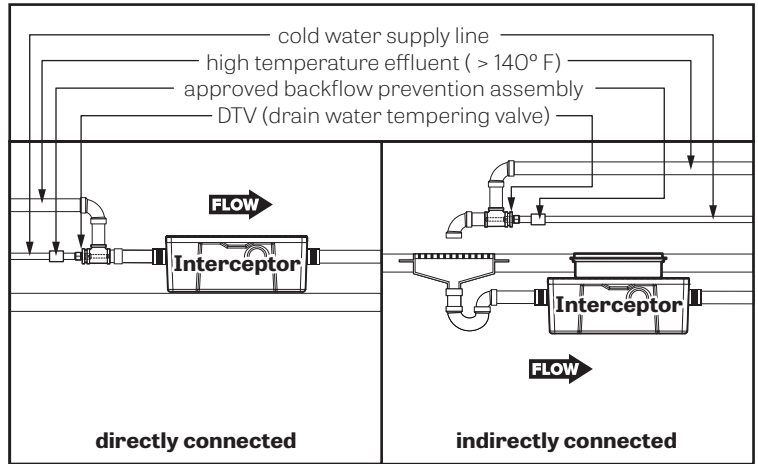

Fully Support Base of Unit

Install unit on solid, level surface in contact with the entire footprint of unit base; for suspended installations design trapeze to support the wet weight of the unit. Do not partially support unit or suspend unit using metal U-channel to create a trapeze

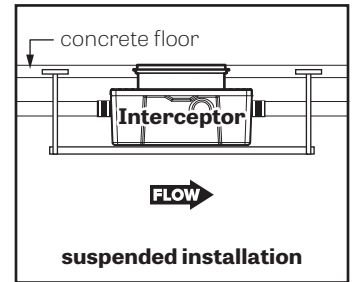

Support Inlet and Outlet Piping

For above grade installations ensure heavy inlet and outlet piping (such as cast iron or long runs) is properly supported or suspended during the entire installation process to prevent connection failure or damage to bulkhead fittings.

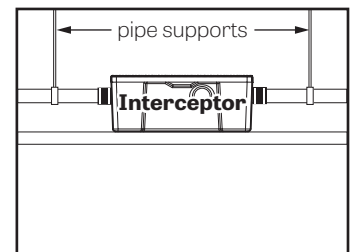

SCHIER
LIFETIME GUARANTEED
GREASE INTERCEPTORS

MODEL NUMBER:
PP1

DESCRIPTION: Pumpout Port Kit

PART #: 8400-011-02

DWG BY: B. Karrer

DATE: 5/16/2018

REV: 2 8/01/2017

ECO: