

### Features

- 36-inch minimum base cabinet width.
- Single bowl.
- 9-inch depth.
- Five oversized faucet holes.
- Oversized holes allow for easy installation of faucets and accessories.
- Bowl slopes 2 degrees toward drain to minimize water pooling.
- Offset drain increases workspace in the sink and storage space underneath.
- Includes K-6194 utility rack with soaking cup, K-6239 colander with integral cutting board, and K-6237 left-hand bottom sink rack.

### Material

- KOHLER® enameled cast iron.

### Installation

- Under-mount

### Recommended Products/Accessories

K-9000 P-Trap  
K-6237 Left-Bowl Sink Rack  
K-6255 Right-Bowl Sink Rack  
K-6377 Sponge Caddy  
K-6378 Kitchen Brush Caddy  
K-6379 Kitchen Squeegee  
K-6382 Disinfecting Wipes Dispenser  
K-6383 Soap Dispenser  
K-8618 Paper Towel Holder  
K-8619 Flexible Kitchen Mat  
K-8624 Dish Scraper  
K-8801 Sink Strainer  
K-8799 Sink Strainer

### Optional Products/Accessories

K-5807 36" Under-mount Sink Kit  
K-6246 Cutting Board

### Included Components

Product consists of:

K-6194 Utility Rack With Soaking Cup  
K-6237 Left-Bowl Sink Rack  
K-6239 Colander with Cutting Board  
1054375 Under-mount Sink Kit, 23"



### Codes/Standards















ASME A112.19.1/CSA B45.2

### KOHLER® Enameled Cast Iron Kitchen Sink Lifetime Limited Warranty

See website for detailed warranty information.

### Available Colors/Finishes

*Color tiles intended for reference only.*

| Color  | Code | Description   |
|--|------|---------------|
|  | 0    | White         |
|  | FF   | Sea Salt™     |
|  | 96   | Biscuit       |
|  | 47   | Almond        |
|  | FD   | Cane Sugar™   |
|  | NY   | Dune          |
|  | 95   | Ice™ Grey     |
|  | G9   | Sandbar       |
|  | K4   | Cashmere      |
|  | FT   | Basalt        |
|  | 58   | Thunder™ Grey |
|  | KA   | Black 'n Tan  |
|  | FP   | Caviar        |
|  | 7    | Black Black™  |

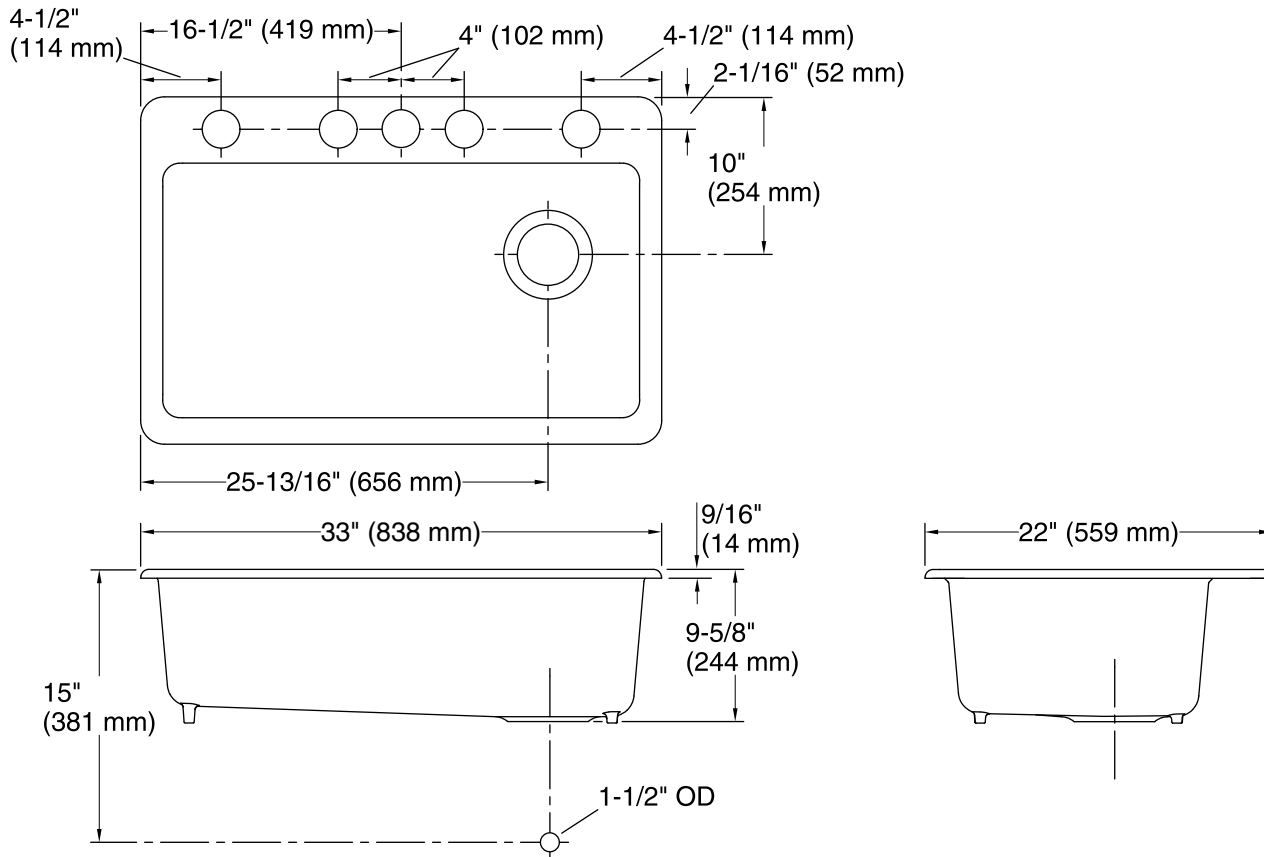

## Technical Information

All product dimensions are nominal.

|                          |  |
|--------------------------|--|
| Bowl configuration:      | Single   |
| Installation:            | Under-mount  |
| Min. base cabinet width: | 36" (914 mm)   |
| Bowl area (Only):        | Length: 30-1/4" (768 mm)<br>Width: 15-13/16" (402 mm)<br>Bowl depth: 9" (229 mm) |
| Number of deck holes:    | 5  |
| Faucet hole(s):          | 2-3/8" (60 mm)   |
| Drain hole:              | 3-7/8" (98 mm)   |
| Template:                | 1166727-7, required, included  |

## Notes

Install this product according to the installation instructions.

**NOTICE:** Countertop manufacturer or cutter must use the cut-out template provided with the product, or a current one provided by Kohler Co. (call 1-800-4-KOHLER). Kohler Co. is not responsible for cutout errors when the incorrect cut-out template is used.