

### Features

- Fits minimum 24-inch base cabinet width.
- Single bowl.
- 9" (229 mm) depth provides generous workspace.
- Shortened apron allows sink to be used in most standard cabinetry or retrofitted to existing standard cabinetry.
- Self-Trimming apron overlaps the cabinet face for easy installation and beautiful results.
- No faucet holes.
- Center drain.
- Includes cutout templates.

### Material

- KOHLER® enameled cast iron.

### Installation

- Undermount farmhouse.

### Recommended Products/Accessories

- K-8395 Sink Rack
- K-8801 Sink Strainer
- K-8799 Sink Strainer
- K-23726 Drain treatment
- K-23725 Cast iron cleaner

### Optional Products/Accessories

- K-11352 Disposal Flange with Stopper
- K-9000 P-Trap

### Included Components

- Additional Components:  
Cutout templates



### Codes/Standards













ASME A112.19.1/CSA B45.2

### KOHLER® Enameled Cast Iron Kitchen Sink Lifetime Limited Warranty

See website for detailed warranty information.

### Available Colors/Finishes

*Color tiles intended for reference only.*

| Color  | Code | Description   |
|--|------|---------------|
|  | 0    | White         |
|  | FF   | Sea Salt™     |
|  | 96   | Biscuit       |
|  | 47   | Almond        |
|  | FD   | Cane Sugar™   |
|  | NY   | Dune          |
|  | 95   | Ice™ Grey     |
|  | G9   | Sandbar       |
|  | K4   | Cashmere      |
|  | FT   | Basalt        |
|  | 58   | Thunder™ Grey |
|  | KA   | Black 'n Tan  |
|  | FP   | Caviar        |
|  | 7    | Black Black™  |
|  | GRL  | Grey Lavender |
|  | DGB  | Indigo Blue   |
|  | PLM  | Black Plum    |

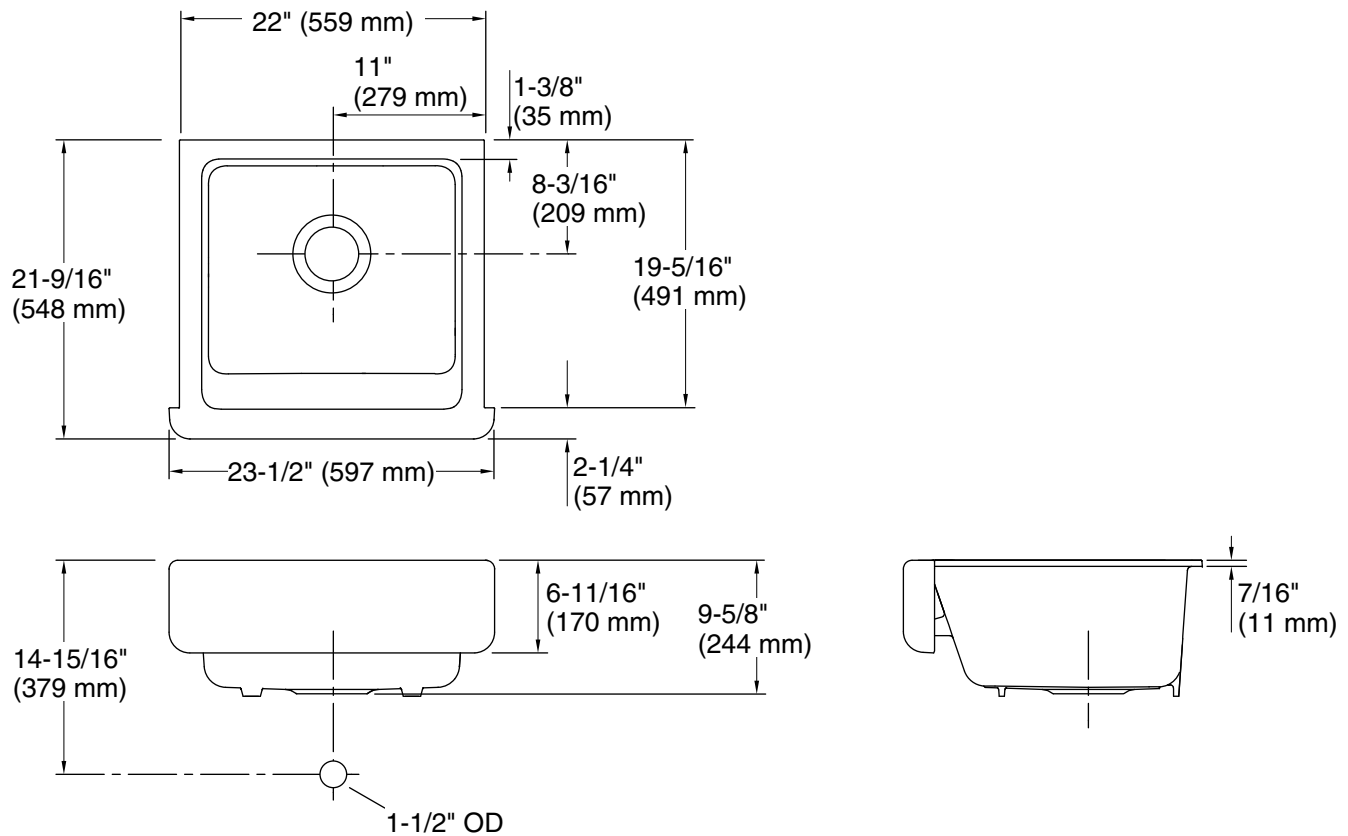

### Technical Information

All product dimensions are nominal.

|                          |   |
|--------------------------|---|
| Bowl configuration:      | Single  |
| Installation:            | Under-mount   |
| Min. base cabinet width: | 24" (610 mm)  |
| Bowl area (Only):        | Length: 18-13/16" (477 mm)<br>Width: 18-1/16" (459 mm)<br>Bowl depth: 9" (229 mm)<br>Water depth: 9" (229 mm) |
| Drain hole:              | 3-5/8" (92 mm)  |
| Template:                | 1247776-7, required, included<br>1239229-7, required, included  |

### Notes

Install this product according to the installation instructions.

**NOTICE:** Countertop manufacturer or cutter must use the current product template available at [www.kohler.com](http://www.kohler.com), or by calling 1-800-4KOHLER. Kohler Co. is not responsible for cutout errors when the incorrect cutout template is used.

**IMPORTANT!** The distance from the top edge of the cabinet to the top of the cabinet door must be at least 6-7/8" (175 mm) to install this sink.