

### Features

- Vitreous china.
- Comfort Height® Elongated bowl.
- AquaPiston® flushing system.
- Includes left-hand polished chrome trip lever.
- 1.28 gpf (4.8 lpf).
- 2-1/8" (54 mm) fully glazed trapway.
- 12" (305 mm) rough-in.
- Less seat and supply.
- 11-3/4" (298 mm) x 9-1/2" (241 mm) water area.
- 30-3/8" (772 mm) x 18-7/8" (479 mm) x 31-1/16" (789 mm).
- Floor mount / Floor outlet.

### Recommended Accessories

K-4636 Cachet® Quiet-Close™ Elongated Toilet Seat  
K-5588 Purefresh® Elongated Toilet Seat  
K-4108 C3®-230 Elongated Cleansing Toilet Seat  
K-5420 Low-Profile Bolt Caps  
K-9167-L Trip Lever  
K-484 Trip Lever

### Components

Product includes:

K-4380 Toilet Bowl  
K-4434 Toilet Tank

Additional included component/s: Tank cover, Trip lever, Bolt cap accessory pack, and Tank accessory pack.



ADA

CSA B651

OBC

### Codes/Standards







ASME A112.19.2/CSA B45.1  
DOE - Energy Policy Act 1992  
EPA WaterSense®  
California Energy Commission (CEC)  
ADA  
ICC/ANSI A117.1  
CSA B651  
OBC

### KOHLER® One-Year Limited Warranty

See website for detailed warranty information.

### Available Color/Finishes

*Color tiles intended for reference only.*

| Color  | Code | Description  |
|--|------|--------------|
|  | 0    | White        |
|  | 96   | Biscuit      |
|  | 47   | Almond       |
|  | NY   | Dune         |
|  | 95   | Ice™ Grey    |
|  | G9   | Sandbar      |
|  | 7    | Black Black™ |

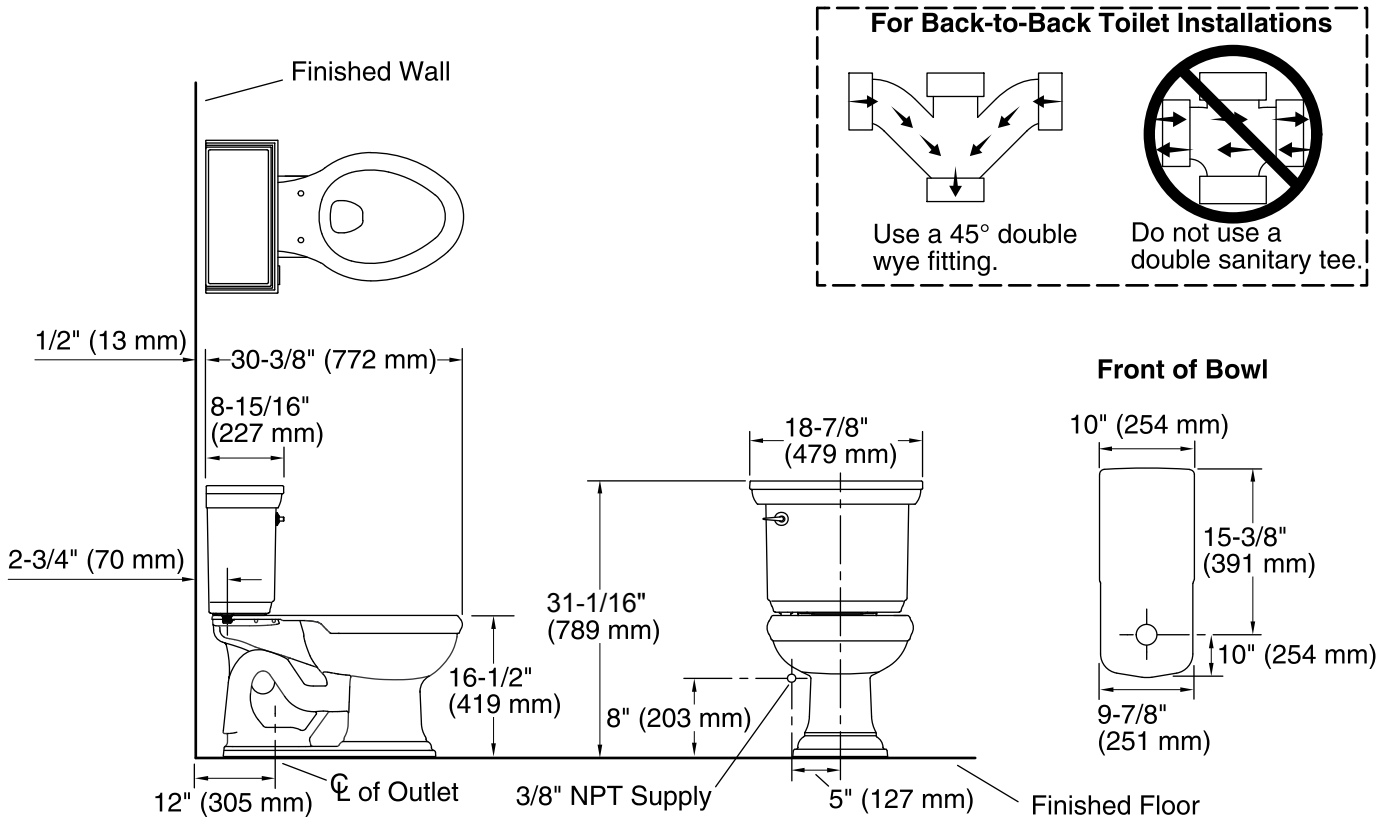

### Technical Information

All product dimensions are nominal.

|                       |                                    |
|-----------------------|------------------------------------|
| Toilet type:          | Two-piece, Floor-mount             |
| Waste Outlet:         | Floor                              |
| Bowl shape:           | Elongated front                    |
| Flush type:           | AquaPiston®                        |
| Trap passageway:      | 2-1/8" (54 mm)                     |
| Water Consumption     |                                    |
| Full:                 | 1.28 gpf (4.8 lpf)                 |
| Water surface size:   | 11-3/4" x 9-1/2" (298 mm x 241 mm) |
| Rim to water surface: | 6-1/8" (156 mm)                    |
| Rough-in:             | 12" (305 mm)                       |
| Seat-mounting holes:  | 5-1/2" (140 mm)                    |

### Notes

Install this product according to the installation instructions.

For back-to-back toilet installations: Use only a 45° double wye fitting.

ADA, OBC, CSA B651 compliant when installed to the specific requirements of these regulations.

Plumbing codes may require elongated toilets and elongated, open-front seats in public bathrooms.

Accessibility standards may require controls to be located on the open side of the toilet.