

### Features

- Intended to replace existing overflow cover and stopper/drain, flange/toggle linkage.
- Toe-tap component installs on most drain bodies with 1-1/2"-11 1/2 NPSM thread.
- For KOHLER drains K-7160-AF, K-7160-TF, K-7161-AF, K-7193.

### Material

- Metal construction.

### Recommended Products/Accessories

K-7160-AF 1-1/2" adjustable pop-up drain  
K-7160-TF 1-1/2" adjustable pop-up drain  
K-7193 Bath Drain  
K-23723 Faucet cleaner



### Codes/Standards









ASME A112.18.2/CSA B125.2

### KOHLER® Faucet Lifetime Limited Warranty

See website for detailed warranty information.

### Available Colors/Finishes

*Color tiles intended for reference only.*

Color	Code	Description
	CP	Polished Chrome
	SN	Vibrant® Polished Nickel
	BN	Vibrant® Brushed Nickel
	BV	Vibrant® Brushed Bronze
	2BZ	Oil-Rubbed Bronze
	BL	Matte Black
	2MB	Vibrant® Brushed Moderne Brass
	TT	Vibrant Titanium

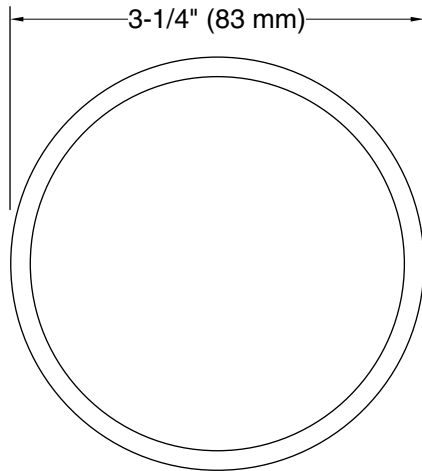

Overflow Cover

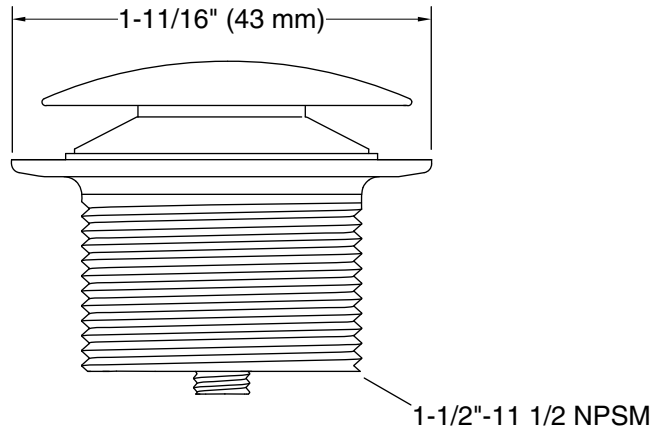

Toe-Tap

### Technical Information

All product dimensions are nominal.

### Notes

Install this product according to the installation instructions.

**IMPORTANT!** This installation should be performed by a qualified plumber.

**IMPORTANT!** Provide access to the back of the bath. Removing the existing overflow cover may effect the seal. Inspect the back of the bath for leaks after completing this retrofit installation.