

### SPECIFICATIONS



#### Features/Benefits

- SnapBack® Retraction System
- Easily Adjustable GripLock® Weight
- 16 3/4" Spout Height, 7 7/8" Spout Reach
- 1.75 gpm (6.6 L/min) Max Flow @ 60 psi
- 2 Function Spray/Aerated Stream
- Ceramic Disc Cartridge
- 300 Degree Swivel Spout
- Single Hole Installation
- Optional Deck Plate, DA665051, Sold Separately

#### Available Color/Finishes

Chrome

Please see [gerber-us.com](http://gerber-us.com) or current price list for available finishes. Finish is defined by additional suffix.

#### Standards & Certifications

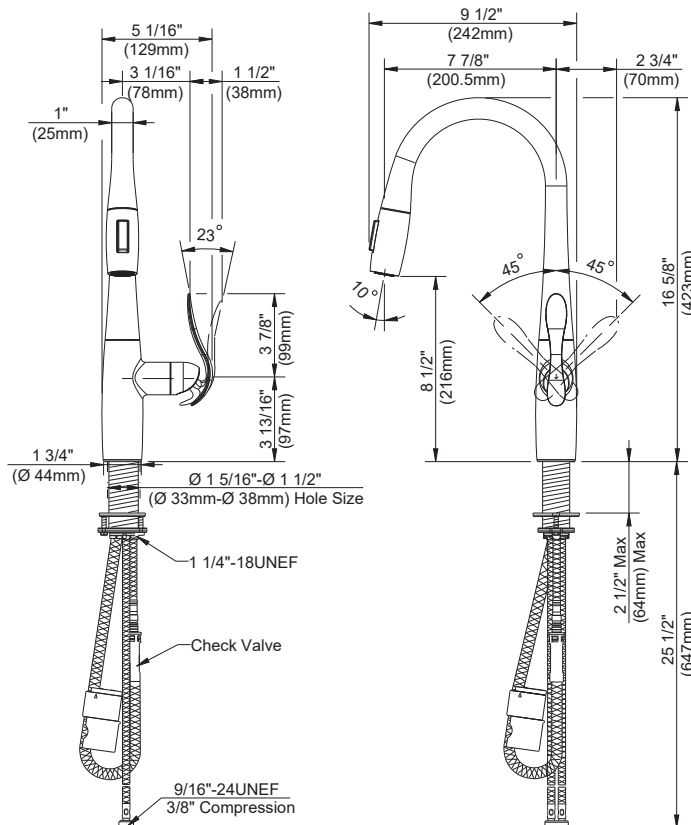

#### Submittal Information:

Name: \_\_\_\_\_  
Location: \_\_\_\_\_

Contractor: \_\_\_\_\_  
Contact #: \_\_\_\_\_