

MSZ-EF09NAB-U2

9,000 BTU/H BLACK DESIGNER WALL-MOUNTED INDOOR UNIT



Job Name:

System Reference:

Date:



GENERAL FEATURES

- Modern, sleek design
- For use with MXZ multi-zone units only
- Multiple control options available:
 - Hand-held Remote Controller (provided with unit)
 - kumo cloud® smart device app for remote access
 - Third-party interface options
 - Wired or wireless controllers

Specifications		System	
Unit Type		MSZ-EF09NAB-U2	
Cooling Capacity ^{1,3}		BTU/H	9,000
Heating Capacity ^{2,3}		BTU/H	10,000
Electrical	Voltage, Phase, Frequency		208/230, 1, 60
	Guaranteed Voltage Range	V AC	187- 253V
	Voltage: Indoor - Outdoor, S1-S2	V AC	208/230
	Voltage: Indoor - Outdoor, S2-S3	V DC	24
	Short-circuit Current Rating [SCCR]	kA	5
Indoor Unit	MCA	A	1.0
	Fan Motor Full Load Amperage	A	0.67
	Airflow Rate at Cooling, Dry	CFM	141–162–222–293–371
	Airflow Rate at Cooling, Wet	CFM	121–140–191–252–319
	Airflow Rate at Heating, Dry	CFM	141–162–219–314–420
	Sound Pressure Level [Cooling]	dB[A]	21–23–29–36–42
	Sound Pressure Level [Heating]	dB[A]	21–24–29–37–45
	Drain Pipe Size	In. [mm]	5/8 [15.88]
	Coating on Heat Exchanger		—
	External Finish Color		Munsell 3.7PB 2.0/0.1
	Unit Dimensions	W x D x H: In. [mm]	34-13/16 x 7-11/16 x 11-3/4 [884 x 195 x 299]
	Package Dimensions	W x D x H: In. [mm]	38-3/4 x 10-3/4 x 14-1/4 [884 x 273 x 362]
	Unit Weight	Lbs. [kg]	26 [11.8]
Package Weight	Lbs. [kg]	29 [13]	
Refrigerant	Type		R410A
Piping	Gas Pipe Size O.D. [Flared]	In.[mm]	3/8 [9.52]
	Liquid Pipe Size O.D. [Flared]	In.[mm]	1/4 [6.35]

NOTES:

Conditions

¹Cooling (Indoor // Outdoor) °F 80 DB, 67 WB // 95 DB, 75 WB
²Heating at 47°F (Indoor // Outdoor) °F 70 DB, 60 WB // 47 DB, 43 WB

³Capacity varies based on the number of indoor units operating and the model of the Multi-zone Outdoor Unit. For reference to connected capacity charts, please refer Multi-zone Outdoor Unit Operational Performance.:

INDOOR UNIT ACCESSORIES: MSZ-EF09NAB-U2

Control Interface	BACnet® and Modbus Interface	PAC-UKPRC001-CN-1
	IT Extender	PAC-WHS01IE-E
	kumo station® for kumo cloud®	PAC-WHS01HC-E
	Lockdown bracket for remote controller	RCMKP1CB
	System Control Interface	MAC-334IF-E
	Thermostat Interface	PAC-US444CN-1
	USNAP Adapter	PAC-WHS01UP-E
Remote Sensor	Wireless temperature and humidity sensor for kumo cloud®	PAC-USWHS003-TH-1
Wired Remote Controller	Deluxe Wired MA Remote Controller†	PAR-40MAAU
	Simple MA Remote Controller†	PAC-YT53CRAU-J
	Touch MA Controller†	PAR-CT01MAU-SB
Wireless Remote Controller	kumo touch™ RedLINK™ Wireless Controller	MHK2
Condensate	Blue Diamond (Advanced) Mini Condensate Pump w/ Reservoir & Sensor (208/230V) [recommended]	X87-721
	Blue Diamond (MicroBlue) Mini Condensate Pump (110/208/230V) up to 18,000 BTU/H	X85-003
	Blue Diamond Alarm Extension Cable—6.5 Ft.	C13-192
	Blue Diamond MultiTank — collection tank for use with multiple pumps	C21-014
	Blue Diamond Sensor Extension Cable — 15 Ft.	C13-103
	Drain Pan Level Sensor/Control	SS610E
	Sauermann Condensate Pump	SI30-230
Disconnect Switch	(30A/600V/UL) [fits 2" X 4" utility box] - White	TAZ-MS303W
Filter	Electro Static Anti-allergy Enzyme Filter	MAC-2320FT-E
Lineset	15' x 1/4" x 15' / 3/8" Lineset (Twin-Tube Insulation)	MLS143812T-15
	30' x 1/4" x 30' / 3/8" Lineset (Twin-Tube Insulation)	MLS143812T-30
	50' x 1/4" x 50' / 3/8" Lineset (Twin-Tube Insulation)	MLS143812T-50
	65' x 1/4" x 65' / 3/8" Lineset (Twin-Tube Insulation)	MLS143812T-65
Soft Dry Cloth	Soft Dry Cloth	MAC-1001CL-E

NOTES:

†Requires MAC-334IF-E

•Allows indoor units to connect to an MA Controller:

- Deluxe MA Remote Controller
- Simple MA Controller
- Touch MA Controller

INDOOR UNIT DIMENSIONS: MSZ-EF09NAB-U2

Unit: inch

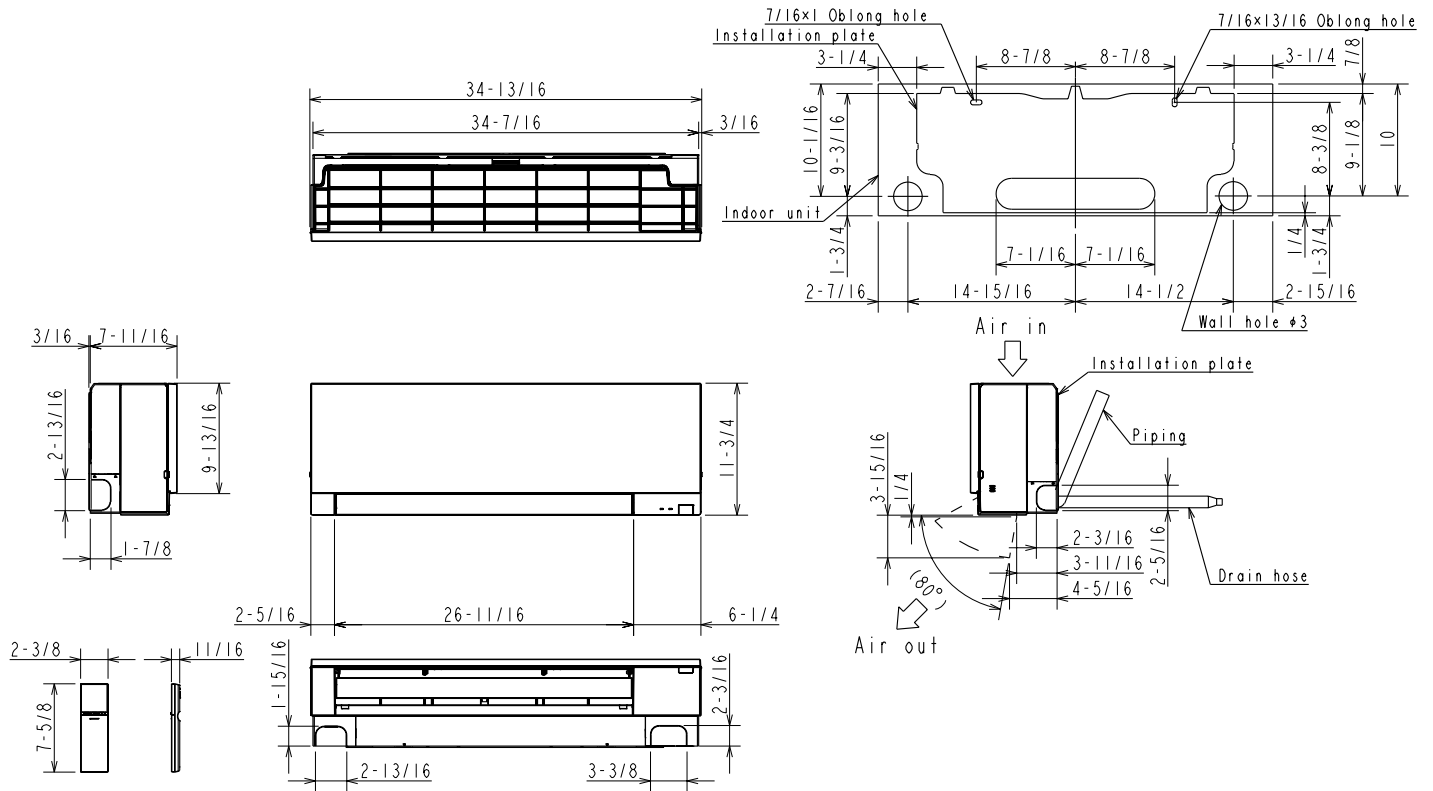

MSZ-EF09/12NA

Piping	Insulation	φ1-7/16 O.D
	Liquid line	φ1/4 - 19-11/16 (Flared connection φ1/4)
	Gas line	φ3/8 - 16-15/16 (Flared connection φ3/8)
Drain hose	Insulation φ1-1/8 Connected part φ5/8 O.D active length 15-3/8	

Note: Extension pipe size refer to the specifications table.

MSZ-EF15/18NA

Piping	Insulation	φ1-7/16 O.D
	Liquid line	φ1/4 - 19-11/16 (Flared connection φ1/4)
	Gas line	φ3/8 - 16-15/16 (Flared connection φ1/2)
Drain hose	Insulation φ1-1/8 Connected part φ5/8 O.D active length 15-3/8	

Note: Extension pipe size refer to the specifications table.