

PROVIDENCE® TUB & SHOWER

A. TEMPASSURE® THERMOSTATIC TUB/SHOWER

T60410-BN; Showerhead Max Flow: 2.5 gpm @ 80 psi;
MultiChoice® Universal Rough R60000-UNBX
TEMPASSURE® THERMOSTATIC SHOWER ONLY
(not shown) T60210-BN; R60000-UNBX

B. TRADITIONAL PRESSURE BALANCE TUB/SHOWER

T60P410-BN; Showerhead Max Flow: 2.0 gpm @ 80 psi
MultiChoice® Universal Rough R60000-UNBX
TRADITIONAL PRESSURE BALANCE SHOWER ONLY
(not shown) T60P210-BN; R60000-UNBX

C. 11" CEILING MOUNT RAINCAN SHOWERHEAD

83310-BN 11" showerhead; RP48985BN 6" arm
Max Flow: 2.5 gpm @ 80 psi, 9.5 L/min @ 550 kPa

D. 9" RAINCAN SHOWERHEAD

RP52090BN
9" showerhead; RP54168PN 16" arm
Max Flow: 2.5 gpm @ 80 psi, 9.5 L/min @ 550 kPa

E. TRADITIONAL SLIDE BAR HANDSHOWER

85710-BN
Bar: 23 1/4"; Hose: 60"
Max Flow: 2.0 gpm @ 80 psi, 7.6 L/min @ 550 kPa

F. TRADITIONAL WALL MOUNT HANDSHOWER

85810-BN
RP36004BN Wall Mount Elbow; Hose: 60"
Max Flow: 2.0 gpm @ 80 psi, 7.6 L/min @ 550 kPa

G. WALL MOUNT HANDSHOWER

RP41202BN
RP36004BN Wall Mount Elbow; Hose: 60"
Max Flow: 2.0 gpm @ 80 psi, 7.6 L/min @ 552 kPa

H. TRADITIONAL HYDRATI™ 2|1 SHOWER WITH

H₂OKINETIC® TECHNOLOGY 86200-BN
RP62929BN 7" arm; Hose: 60"
Max Flow: 2.5 gpm @ 80 psi, 9.5 L/min @ 550 kPa

I. PROVIDENCE BELLE HANDSHOWER*

6016-BNLHP
Flow: 2.0 gpm @ 80 psi
FRENCH LEVER HANDLE HK37(C/H)-BN
CROSS HANDLE (not shown) HK33(C/H)-BN
LEVER HANDLES (not shown) HK36-BN
PROVIDENCE CLASSIC HANDSHOWER (not shown)
6010-BNLHP

J. PROVIDENCE BELLE ROMAN TUB*

6726-BNLHP
Height: 8 1/4" Reach: 9" Max Flow: 18 gpm @ 60 psi
FRENCH LEVER HANDLES HK37(C/H)-BN
CROSS HANDLES (not shown) HK33(C/H)-BN
LEVER HANDLES (not shown) HK36-BN
PROVIDENCE CLASSIC ROMAN TUB (not shown)
6720-BNLHP

K. SOOTHING HYDRACHOICE™ SPRAY HEAD WITH

H₂OKINETIC® TECHNOLOGY SH84100-BN; T84613-BN
Height: 3 1/2" Width: 3 1/2" Max Flow: 1.5 gpm @ 80 psi
Hydrachoice™ Rough R84100

L. TOUCH-CLEAN® HYDRACHOICE™ SPRAY HEAD

SH84103-BN; T84613-BN
Height: 3 1/2" Width: 3 1/2" Max Flow: 1.5 gpm @ 80 psi
Hydrachoice™ Rough R84100

M. MASSAGING HYDRACHOICE™ SPRAY HEAD WITH

H₂OKINETIC® TECHNOLOGY SH84101-BN; T84613-BN
Height: 3 1/2" Width: 3 1/2" Max Flow: 1.5 gpm @ 80 psi
Hydrachoice™ Rough R84100

N. INVIGORATING HYDRACHOICE™ SPRAY HEAD WITH

H₂OKINETIC® TECHNOLOGY SH84102-BN; T84613-BN
Height: 3 1/2" Width: 3 1/2" Max Flow: 1.5 gpm @ 80 psi
Hydrachoice™ Rough R84100

O. 24" ADA COMPLIANT TRADITIONAL GRAB BAR*

69310-NK; Diameter: 1 1/4" Width From Wall: 2 3/4"
12" ADA COMPLIANT TRADITIONAL GRAB BAR*
(not shown) 69210-NK

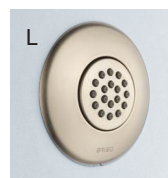
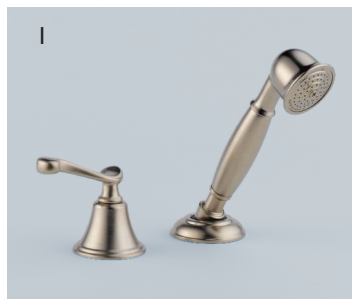
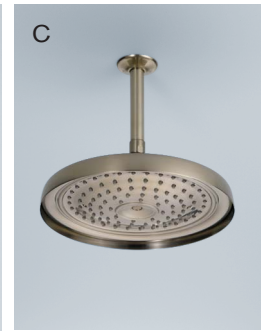

*Select models and accessories not available in all finishes.

QUIESSENCE® TUB & SHOWER

- A. TEMPASSURE® THERMOSTATIC TUB/SHOWER**
T60475-BN; Showerhead Max Flow: 2.0 gpm @ 80 psi;
MultiChoice® Universal Rough R60000-UNBX
TEMPASSURE® THERMOSTATIC SHOWER ONLY
(not shown) T60275-BN; R60000-UNBX
- B. EURO PRESSURE BALANCE TUB/SHOWER**
T60P420-BN; Showerhead Max Flow: 2.0 gpm @ 80 psi
MultiChoice® Universal Rough R60000-UNBX
EURO PRESSURE BALANCE SHOWER ONLY
(not shown) T60P220-BN; R60000-UNBX
- C. 8" CEILING MOUNT RAINCAN SHOWERHEAD**
81375-BN; 8" showerhead; RP48985BN 6" arm
Max Flow: 2.5 gpm @ 80 psi, 9.5 L/min @ 550 kPa
- D. RAINCAN SHOWERHEAD WITH H₂OKINETIC® TECHNOLOGY** 87375-BN
5³/₈" showerhead; RP71648BN 16" arm
Max Flow: 2.0 gpm @ 80 psi, 7.6 L/min @ 550 kPa
- E. SLIDE BAR HANDSHOWER WITH H₂OKINETIC® TECHNOLOGY** 88775-BN
Bar: 22"; Hose: 60"
Max Flow: 2.0 gpm @ 80 psi, 7.6 L/min @ 550 kPa
- F. WALL MOUNT HANDSHOWER WITH H₂OKINETIC® TECHNOLOGY** 88875-BN; Hose: 60"
Max Flow: 2.0 gpm @ 80 psi, 7.6 L/min @ 550 kPa
- G. EURO SLIDE BAR HANDSHOWER** 85521-BN
Bar: 35"; Hose: 60"
Max Flow: 2.0 gpm @ 80 psi, 7.6 L/min @ 550 kPa
- H. EURO ROUND HYDRATI™ 2|1 SHOWER WITH H₂OKINETIC® TECHNOLOGY** 86275-BN
RP74751BN 7" arm; Hose: 60"
Max Flow: 2.5 gpm @ 80 psi, 9.5 L/min @ 550 kPa
- I. ROMAN TUB WITH HANDSHOWER** T67214-BN
Height: 7" Reach: 9³/₄" Max Flow: 12.28 gpm @ 60 psi
- J. SOOTHING HYDRACHOICE™ SPRAY HEAD WITH H₂OKINETIC® TECHNOLOGY** SH84100-BN; T84613-BN
Height: 3¹/₂" Width: 3¹/₂" Max Flow: 1.5 gpm @ 80 psi
Hydrachoice™ Rough R84100
- K. TOUCH-CLEAN® HYDRACHOICE™ SPRAY HEAD**
SH84103-BN; T84613-BN
Height: 3¹/₂" Width: 3¹/₂" Max Flow: 1.5 gpm @ 80 psi
Hydrachoice™ Rough R84100
- L. MASSAGING HYDRACHOICE™ SPRAY HEAD WITH H₂OKINETIC® TECHNOLOGY** SH84101-BN; T84613-BN
Height: 3¹/₂" Width: 3¹/₂" Max Flow: 1.5 gpm @ 80 psi
Hydrachoice™ Rough R84100
- M. INVIGORATING HYDRACHOICE™ SPRAY HEAD WITH H₂OKINETIC® TECHNOLOGY** SH84102-BN; T84613-BN
Height: 3¹/₂" Width: 3¹/₂" Max Flow: 1.5 gpm @ 80 psi
Hydrachoice™ Rough R84100
- N. 24" ADA COMPLIANT CONTEMPORARY GRAB BAR***
69375-NK; Diameter: 1¹/₄" Width From Wall: 2³/₄"
12" ADA COMPLIANT CONTEMPORARY GRAB BAR*
(not shown) 69275-NK



*Select models and accessories not available in all finishes.

VESI® TUB & SHOWER

A. TEMPASSURE® THERMOSTATIC TUB/SHOWER

T60440-BN; Showerhead Max Flow: 2.5 gpm @ 80 psi
MultiChoice® Universal Rough R60000-UNBX
TEMPASSURE® THERMOSTATIC SHOWER ONLY
(not shown) T60240-BN; R60000-UNBX

B. PRESSURE BALANCE TUB/SHOWER*

T60P440-BN; Showerhead Max Flow: 2.0 gpm @ 80 psi
MultiChoice® Universal Rough R60000-UNBX
PRESSURE BALANCE SHOWER ONLY*
(not shown) T60P240-BN; R60000-UNBX

C. SQUARE CEILING MOUNT RAINCAN SHOWERHEAD

83341-BN; 8" showerhead; RP70764BN 6" arm
Max Flow: 2.5 gpm @ 80 psi, 9.5 L/min @ 550 kPa

D. RAINCAN SHOWERHEAD WITH H₂OKINETIC® TECHNOLOGY

87340-BN
5 1/4" showerhead; RP71649BN 7" arm
Max Flow: 2.0 gpm @ 80 psi, 7.6 L/min @ 552 kPa

E. WALL MOUNT HANDSHOWER

RP41202BN
RP36004BN Wall Mount Elbow; Hose: 60"
Max Flow: 2.0 gpm @ 80 psi, 7.6 L/min @ 552 kPa

F. TRANSITIONAL HYDRATI™ 2|1 SHOWER WITH H₂OKINETIC® TECHNOLOGY

86201-BN
RP71649BN 7" arm; Hose: 60"
Max Flow: 2.5 gpm @ 80 psi, 9.5 L/min @ 550 kPa

G. RAINCAN SHOWERHEAD

RP42431BN
4 7/8" showerhead; RP71649BN 7" arm
Max Flow: 2.5 gpm @ 80 psi, 9.5 L/min @ 550 kPa

H. SOOTHING HYDRACHOICE™ SPRAY HEAD WITH H₂OKINETIC® TECHNOLOGY

SH84100-BN; T84913-BN
Height: 3 1/2" Width: 3 1/2" Max Flow: 1.5 gpm @ 80 psi
Hydrachoice™ Rough R84100

I. MASSAGING HYDRACHOICE™ SPRAY HEAD WITH H₂OKINETIC® TECHNOLOGY

SH84101-BN; T84913-BN
Height: 3 1/2" Width: 3 1/2" Max Flow: 1.5 gpm @ 80 psi
Hydrachoice™ Rough R84100

J. TOUCH-CLEAN® HYDRACHOICE™ SPRAY HEAD

SH84103-BN; T84913-BN
Height: 3 1/2" Width: 3 1/2" Max Flow: 1.5 gpm @ 80 psi
Hydrachoice™ Rough R84100

K. INVIGORATING HYDRACHOICE™ SPRAY HEAD WITH H₂OKINETIC® TECHNOLOGY

SH84102-BN; T84913-BN
Height: 3 1/2" Width: 3 1/2" Max Flow: 1.5 gpm @ 80 psi
Hydrachoice™ Rough R84100

L. CHANNEL ROMAN TUB WITH HANDSHOWER

T67745-BN; Height: 6 1/4" Reach: 9"
Max Flow: 18.0 gpm @ 60 psi; 4-hole rough R64707
CHANNEL ROMAN TUB (not shown) T6745-BN
3-hole rough R62707

M. CURVE ROMAN TUB WITH HANDSHOWER

T67740-BN
Height: 6 3/4" Reach: 9 1/2" Max Flow: 18.0 gpm @ 60 psi
4-hole rough R64707
CURVE ROMAN TUB (not shown) T6740-BN
3-hole rough R62707

N. 24" ADA COMPLIANT TRADITIONAL GRAB BAR*

69310-NK; Diameter: 1 1/4" Width From Wall: 2 3/4"
12" ADA COMPLIANT TRADITIONAL GRAB BAR*
(not shown) 69210-NK

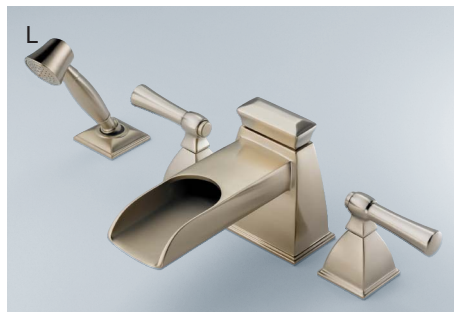
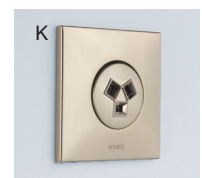
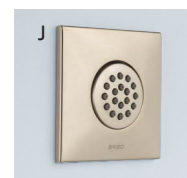
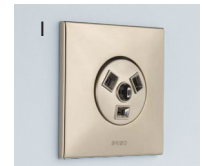

*Select models and accessories not available in all finishes.

HydraChoice™ Max Body Spray System

The new HydraChoice Max Body Spray System offers the clean lines of a flush mount design with maximum flexibility and functionality. The spray heads extend automatically when water is turned on and can be adjusted 50 degrees in any direction, allowing you to aim the water exactly where it's wanted. The system flows at 1.5gpm (5.6 L/min) and offers a choice of four interchangeable spray heads. Spray options include Invigorating, Massaging, and Soothing, all featuring H₂Okinetic® Technology, as well as a Full Spray option featuring Touch-Clean® nozzles. Must order HydraChoice Rough, HydraChoice Max round or square trim, and desired spray head separately.



HYDRACHOICE™
ROUGH
R84100



HYDRACHOICE™
MAX ROUND TRIM
Flow rate:
1.5 gpm @ 80 psi
5.7 L/min @ 550 kPa



T84613-PC
T84613-PN
T84613-NK
T84613-RB
T84613-BN
T84613-BZ
T84613-BL

** must order R84100 (rough)
for each T84613 ordered.*

HYDRACHOICE™
MAX SQUARE TRIM
Flow rate:
1.5 gpm @ 80 psi
5.7 L/min @ 550 kPa



T84913-PC
T84913-PN
T84913-RB
T84913-BN
T84913-BZ
T84913-BL

** must order R84100 (rough)
for each T84913 ordered.*

HYDRACHOICE™
SOOTHING
SPRAY HEAD WITH
H₂O KINETIC®
TECHNOLOGY



SH84100-PC
SH84100-PN
SH84100-NK
SH84100-RB
SH84100-BN
SH84100-BZ
SH84100-BL

HYDRACHOICE™
INVIGORATING
SPRAY HEAD WITH
H₂O KINETIC®
TECHNOLOGY



SH84102-PC
SH84102-PN
SH84102-NK
SH84102-RB
SH84102-BN
SH84102-BZ
SH84102-BL

HYDRACHOICE™
MASSAGING
SPRAY HEAD WITH
H₂O KINETIC®
TECHNOLOGY



SH84101-PC
SH84101-PN
SH84101-NK
SH84101-RB
SH84101-BN
SH84101-BZ
SH84101-BL

HYDRACHOICE™
TOUCH-CLEAN®
SPRAY HEAD



SH84103-PC
SH84103-PN
SH84103-NK
SH84103-RB
SH84103-BN
SH84103-BZ
SH84103-BL