

Product Features

- Type Straight
- 1/4 Turn
- One Piece Body
- Chrome Plated Brass Body
- Chrome Plated Die Cast Zinc Handle
- Brass Stem
- Double O-Ring Design
- 1/2" Press x 3/8" Compression
- Pressure Rating: 125 PSI
- Temperature Rating: 32°F - 160°F
- cUPC, NSF/ANSI 61 and 372 Approved



Model Numbers

4PRO12.38SSPRESS

1/2" Press x 3/8" Comp LF 1/4 Turn Straight Stop

Drawing

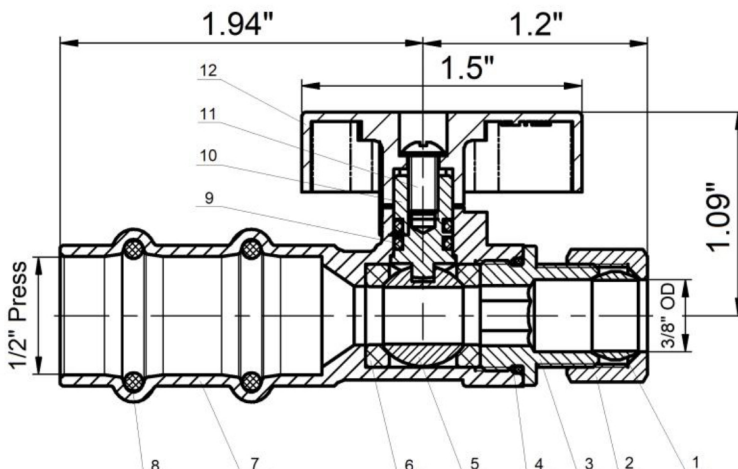

No.	Part	Material	QTY
1	Cutting Sleeve	Brass	1
2	Nut	Brass	1
3	Bonnet	C46500 Brass	1
4	O-Ring	NBR	1
5	Ball	C46500 Brass	1
6	Seal Seat	PTFE	2
7	Body	C46500 Brass	1
8	O-Ring	EPDM	2
9	O-Ring	NBR	2
10	Stem	Brass	1
11	Screw	Stainless Steel	1
12	Handle	Zinc Alloy	1