



AQUAVAR[®] ProPak

30-60 HZ KITS

FEATURES

Simple, fast sizing and installation.

Range curves and selection charts generated from actual R&D tests.

Kits configured for 30 hz minimum and 60 hz maximum operation.

Controller must be set for 60 hz operation.

Kits use matched water end and motor (see component chart).

Wiring is as easy as standard three-wire control box:

- L1, L2 and Ground in from power supply
- Red, Yellow, Black and Ground out to motor

60 PSI Factory Preset Pressure - easily adjusted to higher pressures.

AQUAVAR® SOLO² CONTROLLER FEATURES

More versatile user interface board

- Provides switch connection for optional pressure or level switch
- Current limit settings for Goulds Water Technology and F.E. motors
- Dry well sensitivity switch
- Low pressure cut-off protection
- 5 or 20 PSI pressure drop restart switch
- Transducer better protected from transient power surges

Pressure factory preset at 60 PSI - simple, fast, field adjustability for higher pressures.

Three phase output to motor reduces wire cost.

Goulds Water Technology model GS features the Guardian bearing system and field proven sand and abrasive handling floating stack design.

Switch Input for connecting a pressure switch or float switch.

Grounding provisions for transducer and transducer cable.

KITS INCLUDE:

- Three Phase Motor 1.5 - 5 HP, 230 V
- Aquavar SOLO² Controller with Transducer
- GS Water End (pump)

Order pressure tank separately, not included in kit.

PROPAK PERFORMANCE RANGE AND COMPONENTS

MODEL	HP	Shut-Off Head (ft)	at Best Efficiency		at Maximum Runout		WE	Motor	Controller
			Flow (GPM)	TDH (ft)	Flow (GPM)	TDH (ft)			
7GP1515	1.5	688	7	538	10	386	7GS15	M15432	3AS20
10GP1515	1.5	555	10	440	16	239	10GS15		
18GP1515	1.5	348	18	255	28	126	18GS15		
5GP2020	2	1060	5	740	7.5	440	5GS20	M20432	
7GP2020	2	959	7	701	10	480	7GS20		
10GP2020	2	660	10	546	16	287	10GS20		
18GP2020	2	444	18	324	28	160	18GS20		
25GP2020	2	340	25	227	33	120	25GS20		
7GP3030	3	1200	7	890	10	615	7GS30	M30432	
10GP3030	3	876	10	700	16	368	10GS30		
13GP3030	3	662	13	519	20	250	13GS30		
18GP3030	3	605	18	422	28	215	18GS30		
25GP3030	3	464	25	310	33	165	25GS30		
35GP3030	3	405	35	260	50	75	35GS30		
18GP5050	5	960	18	712	28	365	18GS50	M50432	3AS50
25GP5050	5	800	25	525	33	280	25GS50		
35GP5050	5	659	35	428	50	100	35GS50		

PROPAK KIT DIMENSIONS AND WEIGHTS

Controller	Sh. Weight (lb)	Dimensions - All
3AS20	23	Height: 21"
3AS30	24	Width: 13"
3AS50	29	Depth: 8"

Pump	Sh. Weight (lb)	W. E. Length (in)
7GS15	12	23.6
10GS15	12	18.4
18GS15	10	16.1
5GS20	19	31.6
7GS20	13	27.2
10GS20	13	21.7
18GS20	11	18.6
25GS20	10	17.2
7GS30	18	33.2
10GS30	18	27.5
13GS30	15	22.3
18GS30	15	24.1
25GS30	14	20.9
35GS30	13	24.0
18GS50	21	34.4
25GS50	21	33.4
35GS50	19	35.2

Motors	Sh. Weight (lb)	Motor Length (in)	L x W x H (in)
M15432	23	11.7	19 x 4.1 x 4.1
M20432	28	13.8	20.5 x 6.5 x 6.5
M30432	32	15.3	20.5 x 6.5 x 6.5
M50432	55	21.7	27.5 x 6.5 x 6.5

ProPak Carton Dimensions and Weights

Kit No.	Sh. Weight (lb)	No. cartons	L x W x H (in)
7GP1515	60	1	34.2" x 15.1" x 17.9"
10GP1515	60		
18GP1515	58		
5GP2020	72	1	40.7" x 15.1" x 17.9"
7GP2020	66	1	34.2" x 15.1" x 17.9"
10GP2020	66		
18GP2020	64		
25GP2020	63		
7GP3030	76	1	40.7" x 15.1" x 17.9"
10GP3030	76	1	34.2" x 15.1" x 17.9"
13GP3030	73		
18GP3030	73		
25GP3030	72		
35GP3030	71	1	34.2" x 15.1" x 17.9"
18GP5050	107	2 ^①	40.7" x 15.1" x 17.9"
25GP5050	107		
35GP5050	105		

① The 5 HP units have the controller and pump in one carton and the motor is shipped separately due to weight. See M50432 for motor weight and dimensions.

MODEL 5GS20 30-60 Hz with 2 HP Motor and 3AS20

SELECTION CHART

Pump Model	HP	PSI	Depth to Water in Feet/Ratings in GPM (Gallons Per Minute)																
			300	340	380	420	460	500	540	580	620	660	700	740	780	820	860	900	940
5GS20	2	0					7.4	7.1	6.8	6.4	6.1	5.7	5.4	5.0	4.7	4.3	3.9	3.3	2.7
		50		7.5	7.2	6.8	6.5	6.1	5.8	5.4	5.1	4.7	4.3	3.9	3.4	2.8	2.1		
		60	7.6	7.3	7.0	6.6	6.3	5.9	5.6	5.2	4.9	4.5	4.1	3.6	3.1	2.4	1.6		
Shut-off PSI			328	311	293	276	259	242	224	207	190	172	155	138	120	103	86	68	51

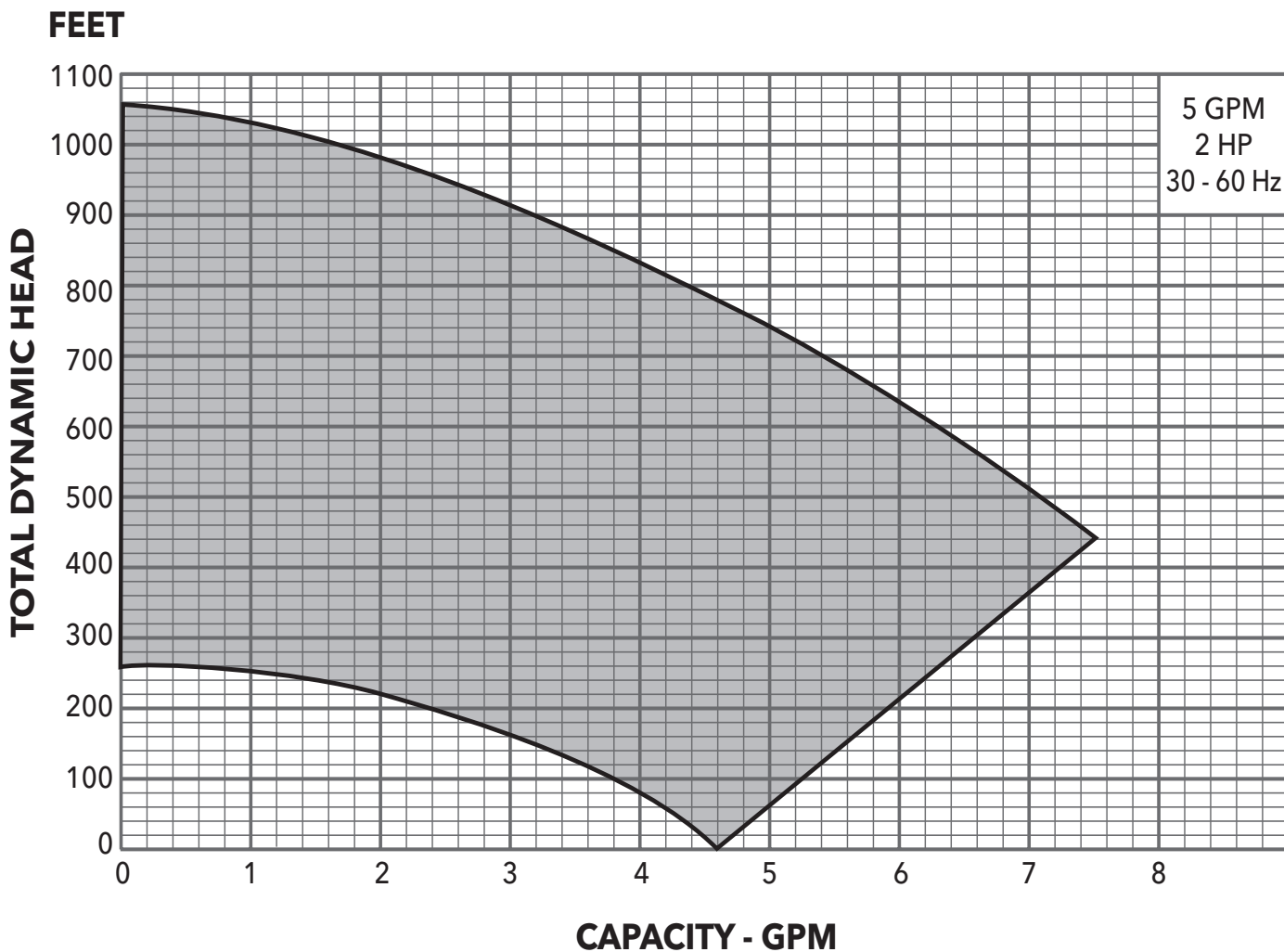

MODEL 7GS15 30-60 Hz with 1.5 HP Motor and 3AS20

SELECTION CHART

Pump Model	HP	PSI	Depth to Water in Feet/Ratings in GPM (Gallons Per Minute)												
			240	260	280	300	340	380	420	460	500	540	580	620	660
7GS15	1½	0						10.2	9.3	8.5	7.6	6.8	5.9	4.7	2.6
		50		10.3	9.9	9.4	8.6	7.7	6.9	6.0	4.9	2.9			
		60	10.2	9.8	9.4	8.9	8.1	7.2	6.4	5.4	3.9				
Shut-off PSI			194	186	177	168	151	134	116	99	82	64	47	30	12

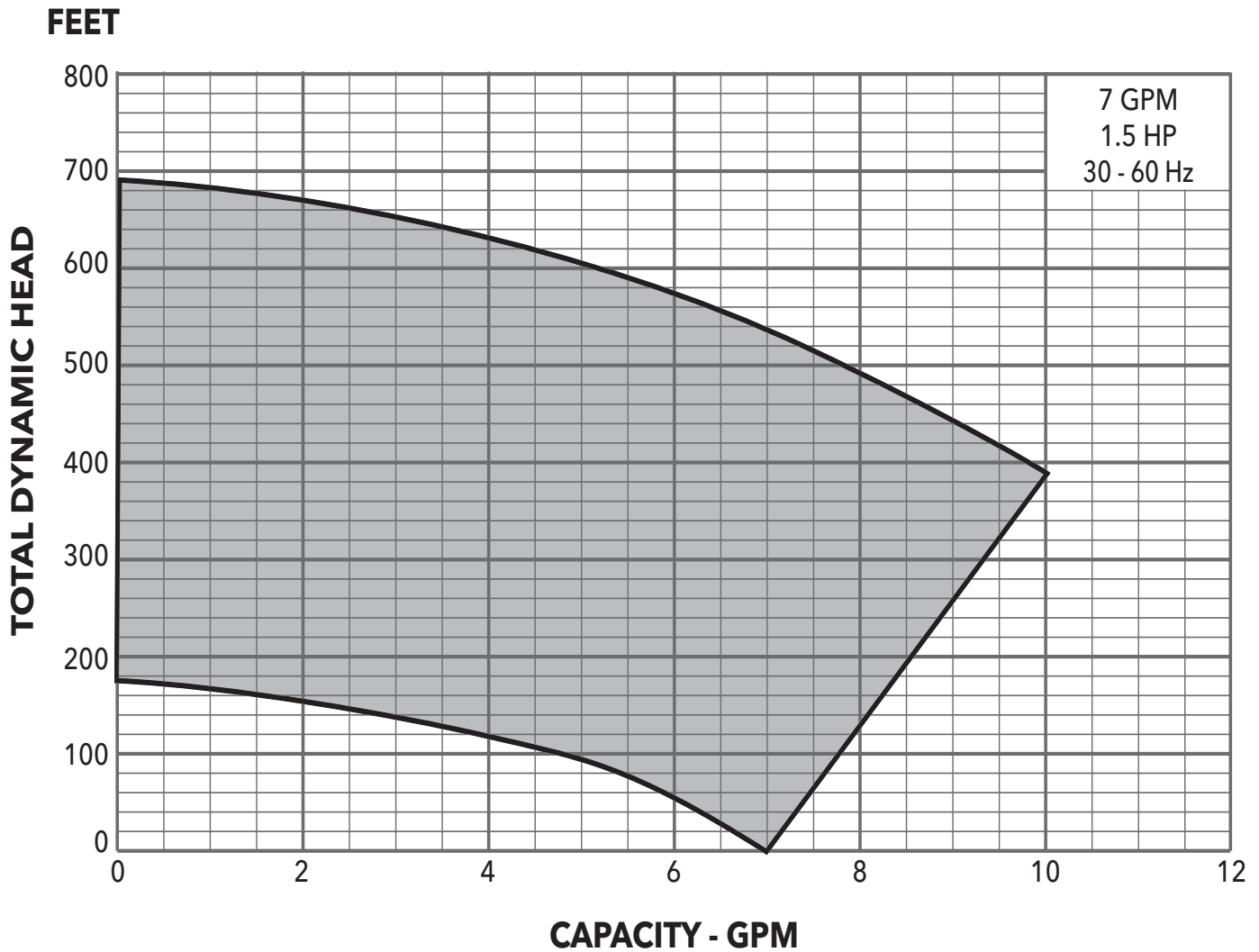

MODEL 7GS20 30-60 Hz with 2 HP Motor and 3AS20

SELECTION CHART

Pump Model	HP	PSI	Depth to Water in Feet/Ratings in GPM (Gallons Per Minute)														
			340	380	420	460	500	540	580	620	660	700	740	780	820	860	900
7GS20	2	0					9.8	9.3	8.7	8.4	7.8	7.1	6.3	5.4	4.5	3.5	2.2
		50		9.9	9.4	8.9	8.5	7.8	7.2	6.3	5.5	4.7	3.5				
		60	10.0	9.6	9.1	8.7	8.2	7.4	6.6	5.8	5.0	4.0					
Shut-off PSI			268	251	234	216	199	182	165	147	130	113	95	80	61	43	26

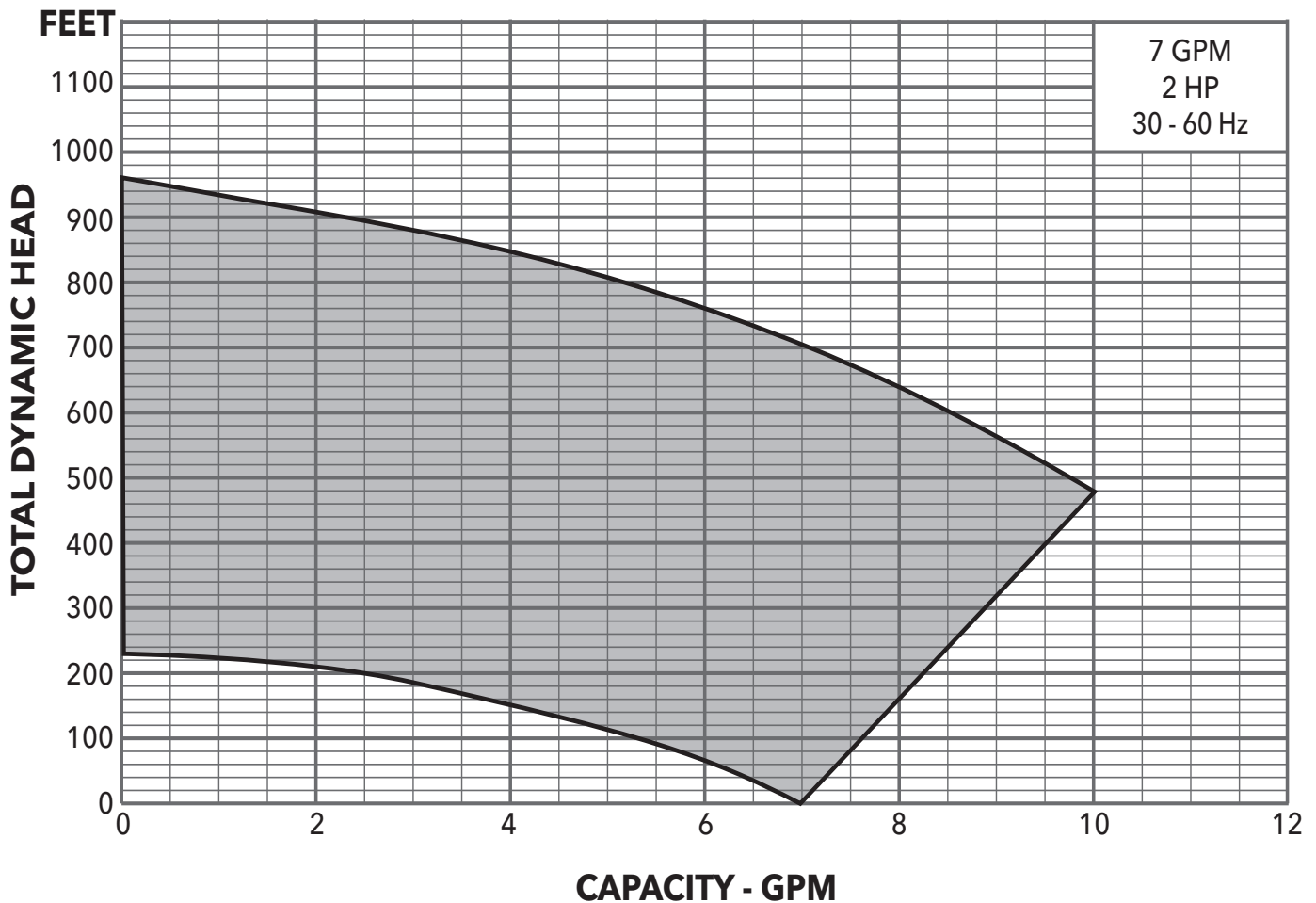

MODEL 7GS30 30-60 Hz with 3 HP Motor and 3AS30

SELECTION CHART

Pump Model	HP	PSI	Depth to Water in Feet/Ratings in GPM (Gallons Per Minute)																	
			460	500	540	580	620	660	700	740	780	820	860	900	940	980	1020	1060	1100	1140
7GS30	3	0					9.8	9.5	9.2	8.7	8.3	7.9	7.4	6.8	6.2	5.4	4.7	3.9	3.0	2.0
		50		9.9	9.5	9.2	8.7	8.4	7.9	7.4	6.8	6.3	5.5	4.8	3.9	3.1	2.2			
		60	10.0	9.7	9.3	9.0	8.6	8.1	7.6	7.0	6.5	5.8	5.1	4.2	3.4	2.5	1.5			
Shut-off PSI			320	303	286	268	251	234	216	199	182	165	147	130	113	95	78	61	43	27

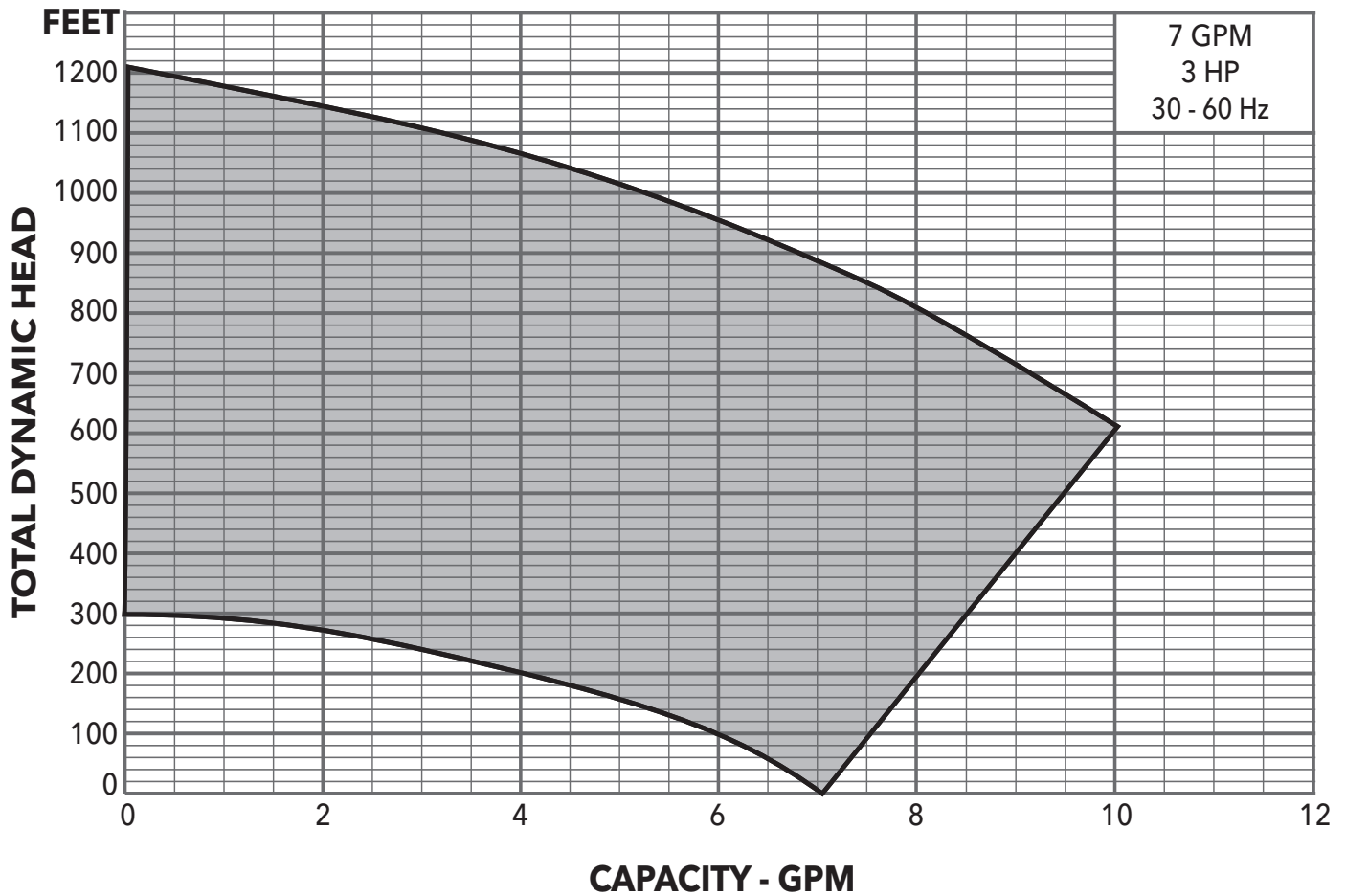

MODEL 10GS15 30-60 Hz with 1.5 HP Motor and 3AS20

SELECTION CHART

Pump Model	HP	PSI	Depth to Water in Feet/Ratings in GPM (Gallons Per Minute)																		
			100	120	140	160	180	200	220	240	260	280	300	340	380	420	460	500	540		
10GS15	1½	0									15.7	15.3	14.8	14.4	13.3	12.2	10.9	9.3	7.1	3.0	
		50		15.7	15.4	14.9	14.5	14.0	13.4	12.8	12.3	11.7	11.0	9.4	7.4	3.4					
		60	15.7	15.3	14.8	14.4	13.9	13.3	12.8	12.2	11.6	10.9	10.1	8.1	5.6						
Shut-off PSI			197	188	180	171	162	154	144	136	128	119	110	93	76	58	41	24	6		

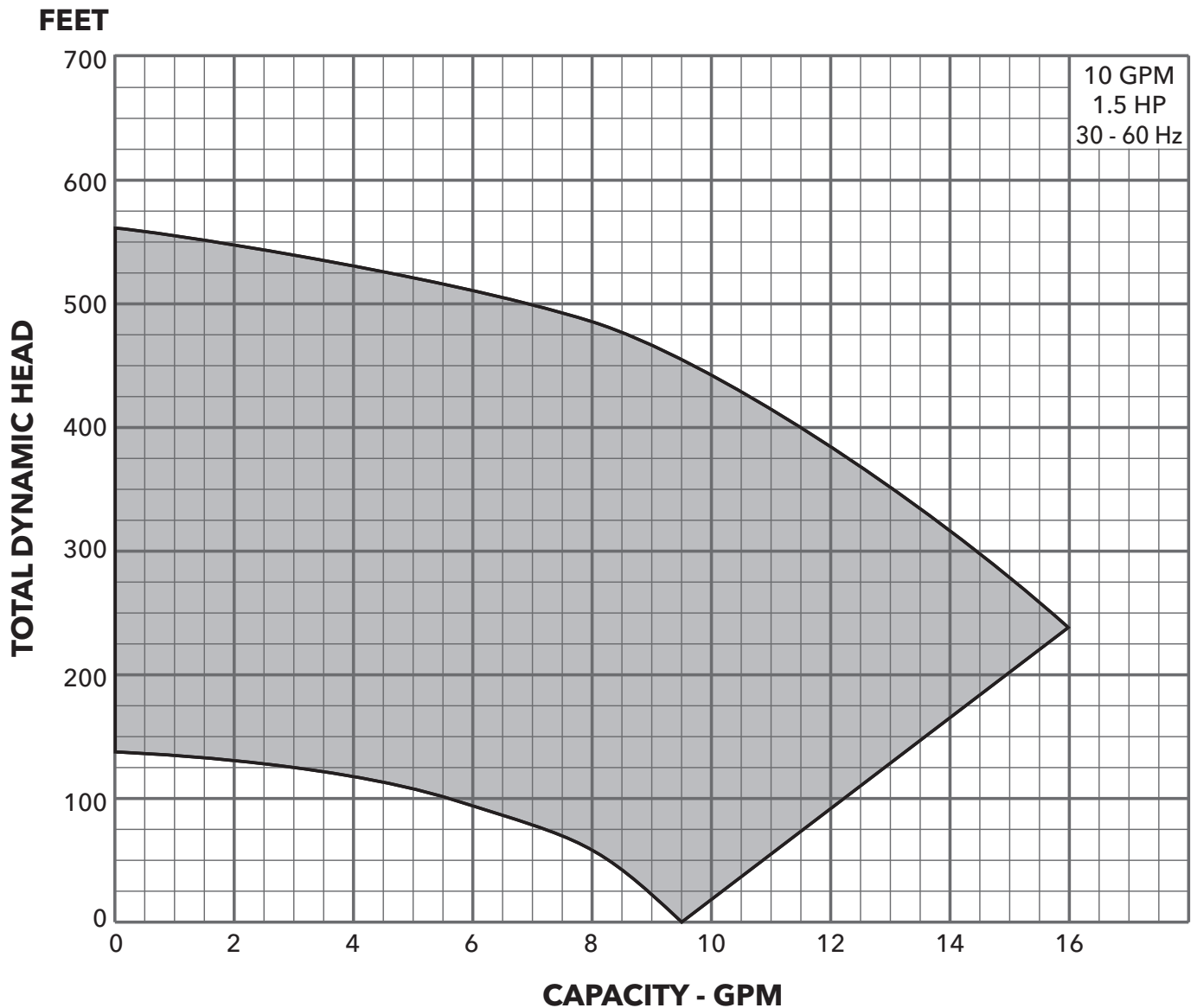

MODEL 10GS20 30-60 Hz with 2 HP Motor and 3AS20

SELECTION CHART

Pump Model	HP	PSI	Depth to Water in Feet/Ratings in GPM (Gallons Per Minute)																
			140	160	180	200	220	240	260	280	300	340	380	420	460	500	540	580	620
10GS20	2	0								16.0	15.7	14.9	14.2	13.4	12.4	11.4	10.0	8.2	5.8
		50		16.1	15.7	15.3	15.0	14.6	14.2	14.0	13.4	12.5	11.5	10.1	8.5	6.0			
		60	16.0	15.7	15.3	14.9	14.5	14.2	13.8	13.4	12.8	11.8	10.7	9.1	7.2	3.4			
Shut-off PSI			225	216	208	199	190	182	173	164	156	139	121	104	87	69	52	35	17

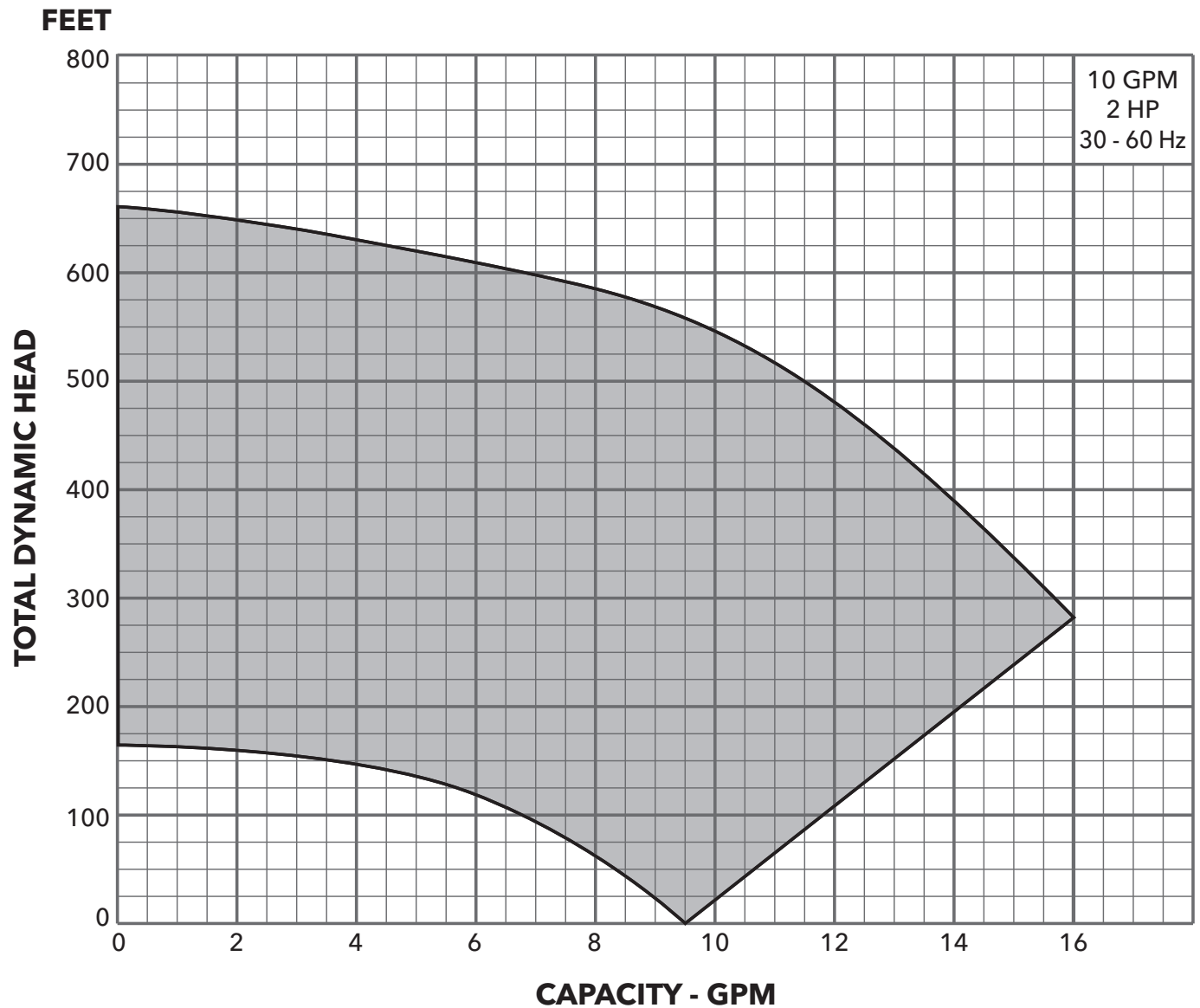

MODEL 10GS30 30-60 Hz with 3 HP Motor and 3AS30

SELECTION CHART

Pump Model	HP	PSI	Depth to Water in Feet/Ratings in GPM (Gallons Per Minute)																		
			220	240	260	280	300	340	380	420	460	500	540	580	620	660	700	740	780	820	
10GS30	3	0							15.8	15.2	14.6	14.0	13.3	12.6	11.9	11.0	10.0	9.0	7.5	5.8	
		50		16.0	15.8	15.6	15.3	14.7	14.1	13.3	12.7	11.9	11.0	10.2	9.1	7.8	6.0	3.0			
		60	16.0	15.8	15.5	15.2	14.8	14.3	13.7	12.9	12.3	11.4	10.6	9.6	8.3	6.8	4.5				
Shut-off PSI			284	275	267	258	249	232	215	197	180	163	145	128	111	94	76	59	42	24	

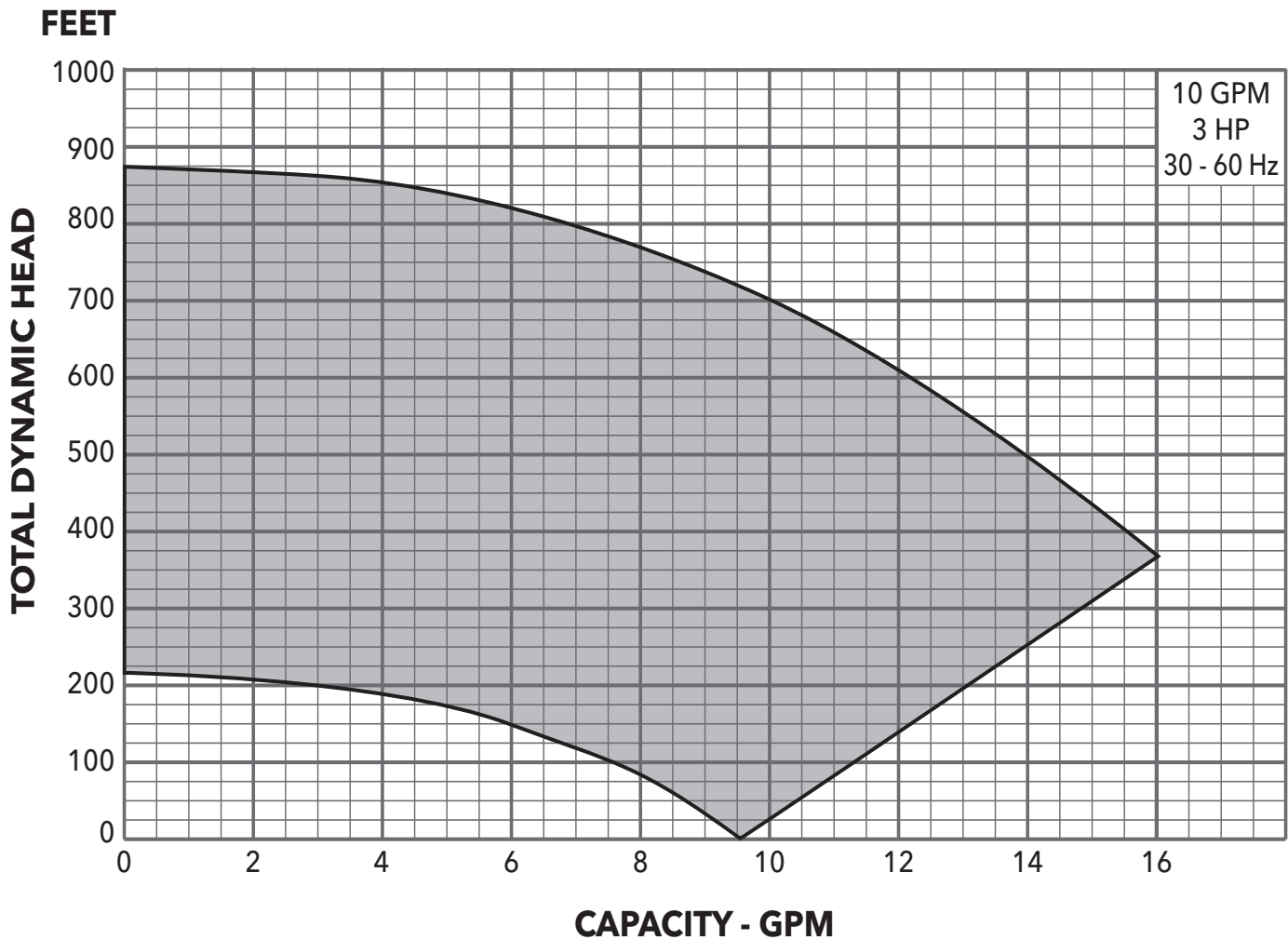

MODEL 13GS30 30-60 Hz with 3 HP Motor and 3AS30

SELECTION CHART

Pump Model	HP	PSI	Depth to Water in Feet/Ratings in GPM (Gallons Per Minute)																	
			120	140	160	180	200	220	240	260	280	300	340	380	420	460	500	540	580	620
13GS30	3	0								19.8	19.4	18.9	18.0	17.1	16.0	14.6	13.5	11.9	10.0	7.3
		50		19.9	19.5	19.0	18.6	18.1	17.7	17.2	16.7	16.1	14.9	13.7	12.0	10.1	7.9			
		60	19.8	19.4	18.9	18.5	18.0	17.5	17.1	16.6	16.0	15.4	14.2	12.9	11.0	9.0	5.0			
Shut-off PSI			235	226	217	209	200	191	183	174	165	157	139	122	104	87	70	53	35	18

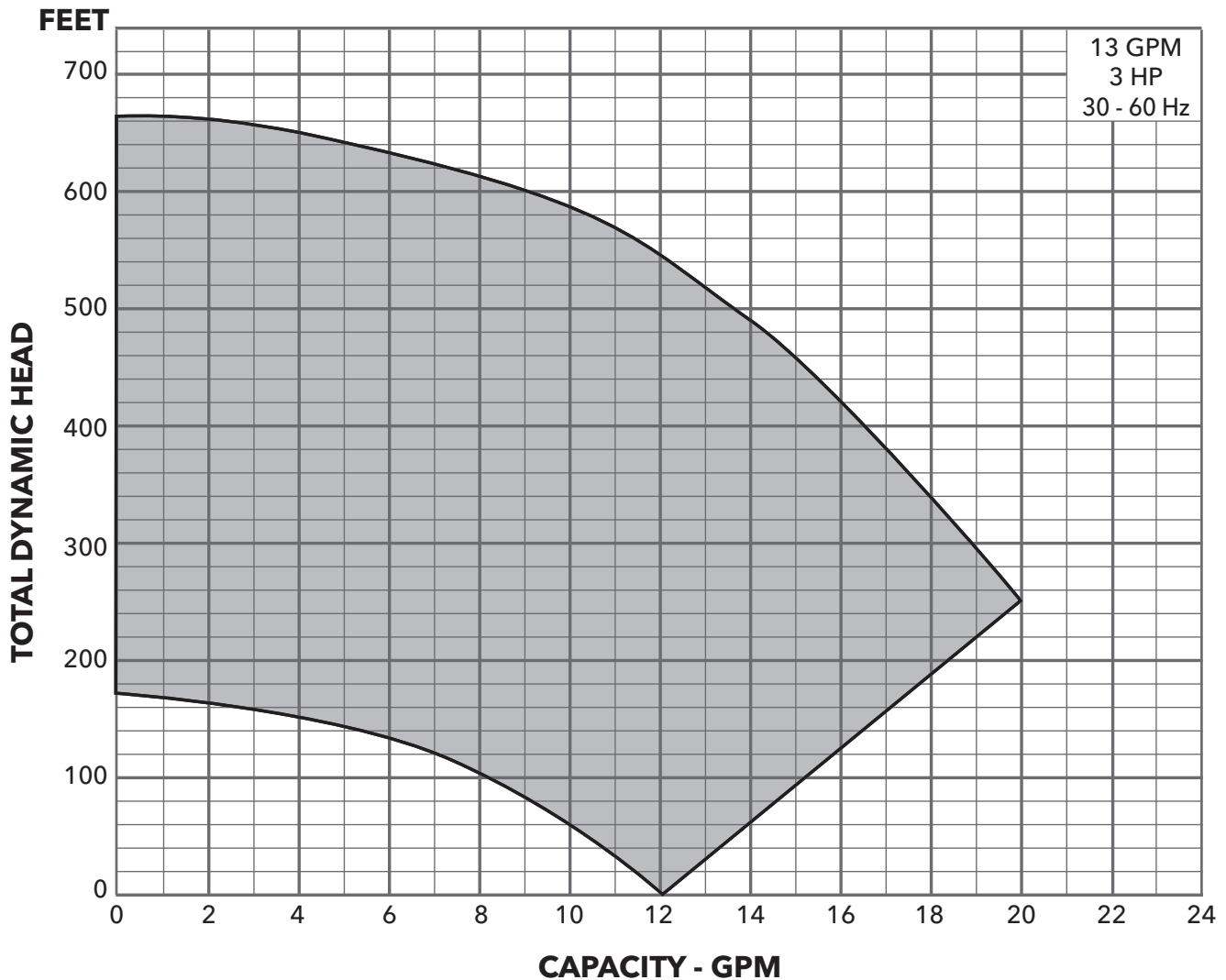

MODEL 18GS15 30-60 Hz with 1.5 HP Motor and 3AS20

SELECTION CHART

Pump Model	HP	PSI	Depth to Water in Feet/Ratings in GPM (Gallons Per Minute)														
			20	40	60	80	100	120	140	160	180	200	220	240	260	280	300
18GS15	1½	0						28.4	27.2	26.0	24.8	23.0	21.4	19.6	17.5	15.0	12.1
		50	27.6	26.4	25.0	23.4	21.8	20.0	18.0	15.5	13.0	9.2					
		60	26.0	24.6	23.0	21.2	19.5	17.5	15.0	12.0	7.9						
Shut-off PSI			143	134	126	117	108	100	91	82	74	65	56	48	39	30	22

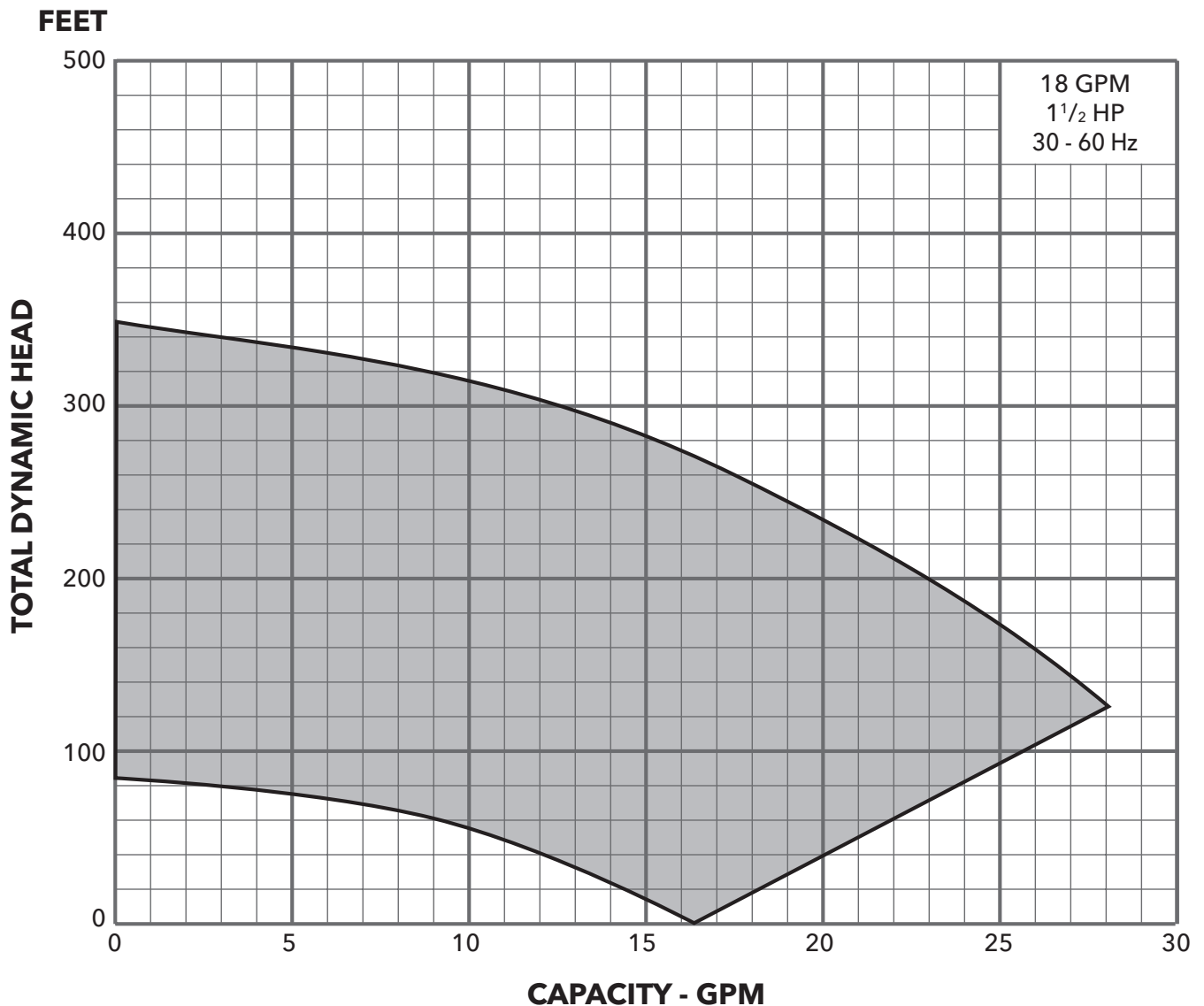

MODEL 18GS20 30-60 Hz with 2 HP Motor and 3AS20

SELECTION CHART

Pump Model	HP	PSI	Depth to Water in Feet/Ratings in GPM (Gallons Per Minute)																
			20	40	60	80	100	120	140	160	180	200	220	240	260	280	300	340	380
18GS20	2	0								28.0	27.1	26.2	25.1	24.0	22.9	21.4	20.0	16.8	12.8
		50		28.0	27.2	26.2	25.3	24.3	23.0	21.8	20.3	18.7	17.0	15.3	13.1	10.5	6.0		
		60	28.0	27.1	26.2	25.1	24.0	22.9	21.4	20.0	18.3	16.8	14.8	12.8	9.5				
Shut-off PSI			183	174	165	157	148	139	131	122	113	105	96	87	79	70	61	44	27

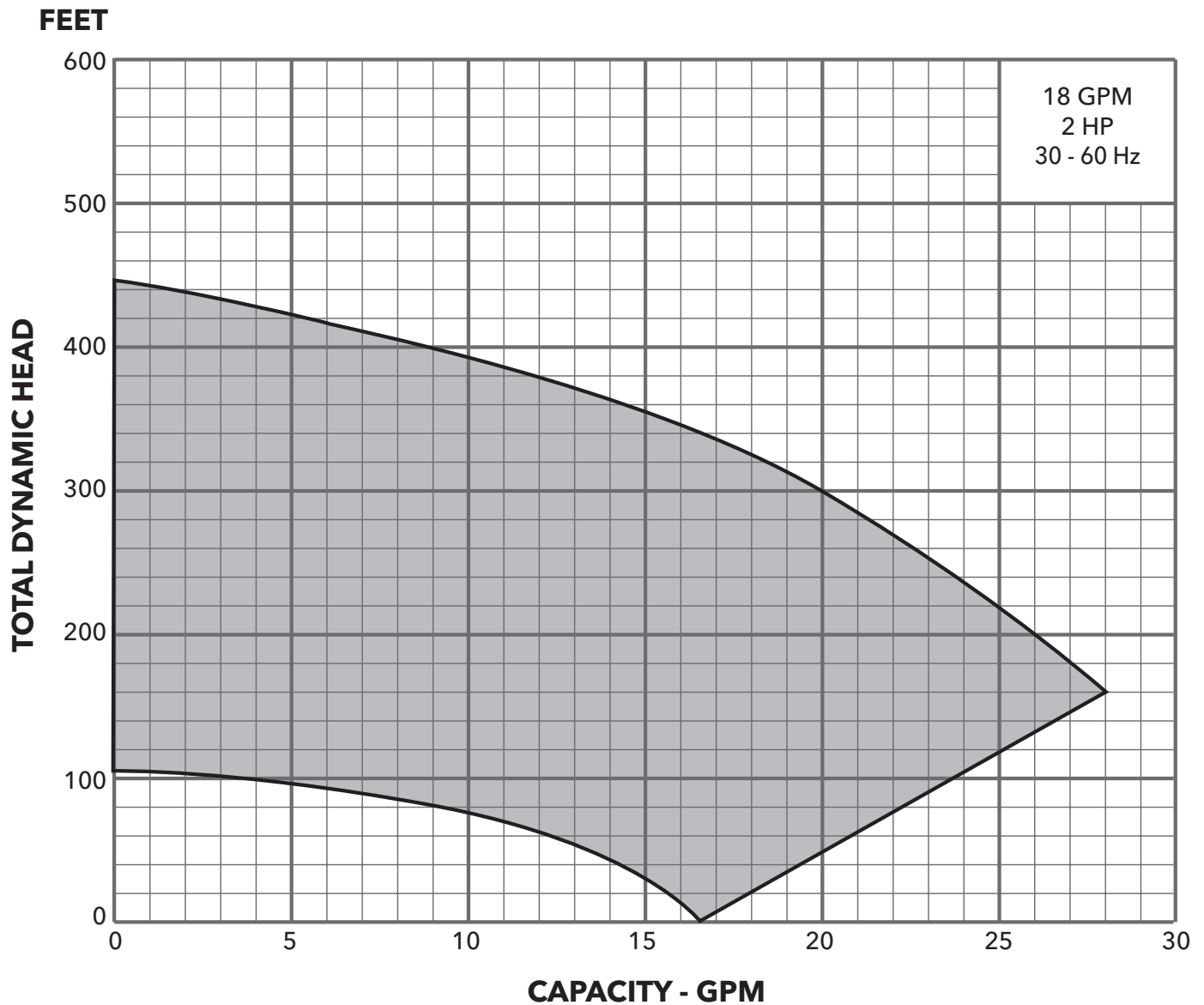

MODEL 18GS30 30-60 Hz with 3 HP Motor and 3AS30

SELECTION CHART

Pump Model	HP	PSI	Depth to Water in Feet/Ratings in GPM (Gallons Per Minute)																	
			80	100	120	140	160	180	200	220	240	260	280	300	340	380	420	460	500	540
18GS30	3	0								28.0	27.4	26.7	26.0	25.0	23.5	21.5	19.2	16.9	14.2	10.5
		50			27.4	26.8	26.0	25.2	24.5	23.6	22.6	21.7	20.6	19.5	17.3	14.5	11.0			
		60	28.0	27.4	26.7	26.0	25.0	24.3	23.5	22.5	21.5	20.5	19.2	18.0	15.7	12.8	7.0			
Shut-off PSI			225	216	208	199	190	182	173	164	156	147	139	130	113	95	78	61	43	26

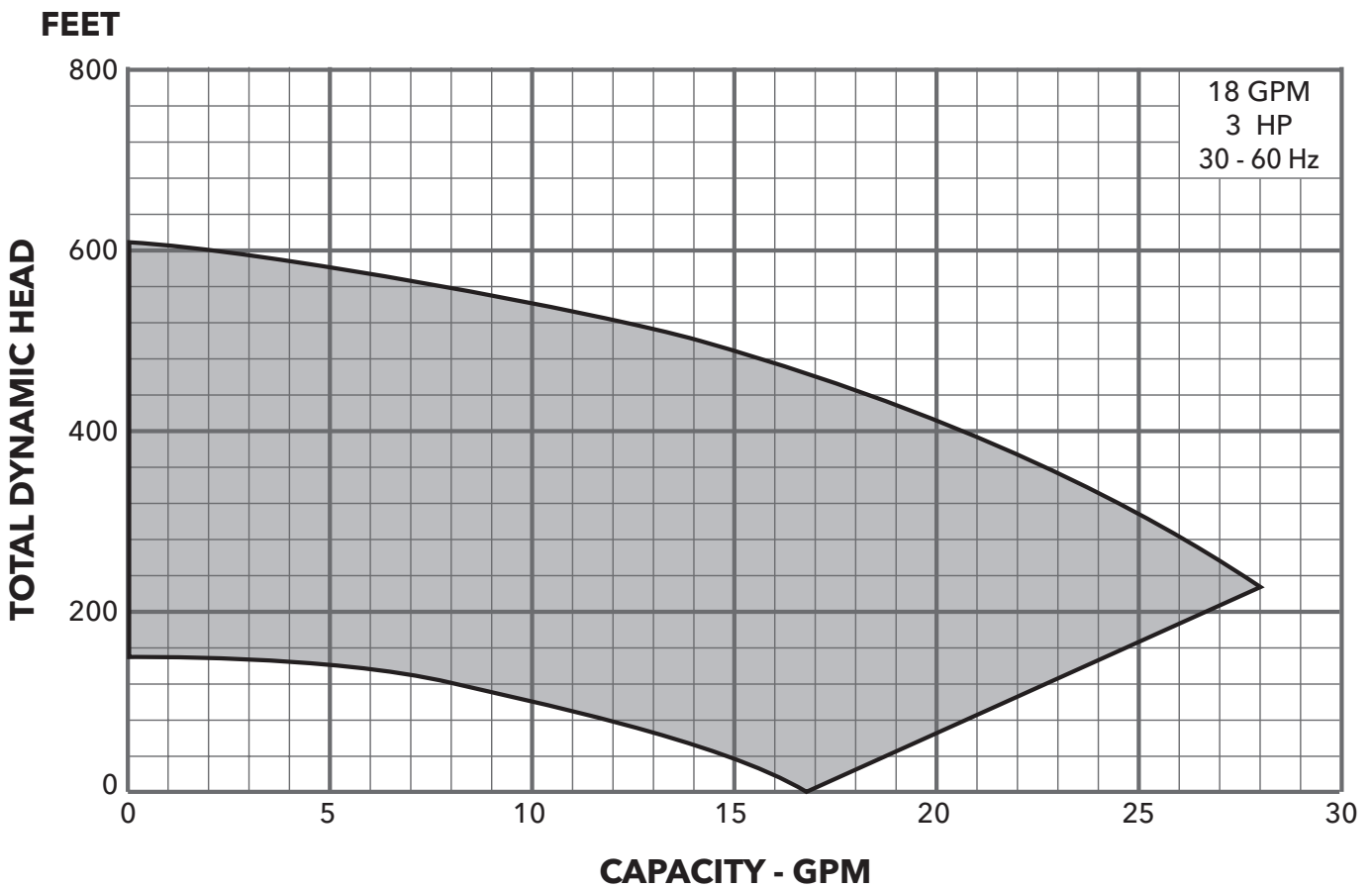

MODEL 18GS50 30-60 Hz with 5 HP Motor and 3AS50

SELECTION CHART

Pump Model	HP	PSI	Depth to Water in Feet/Ratings in GPM (Gallons Per Minute)																	
			240	260	280	300	340	380	420	460	500	540	580	620	660	700	740	780	820	860
18GS50	5	0						27.9	26.8	25.8	24.8	23.7	22.6	21.2	19.9	18.4	16.8	14.8	12.4	9.7
		50		27.9	27.3	26.8	25.9	24.9	23.8	22.7	21.3	20.1	18.5	16.9	14.9	12.8	10.0	6.0		
		60	27.9	27.2	26.8	26.2	25.2	24.1	23.0	21.9	20.7	19.2	17.5	15.8	13.6	11.0	7.8			
Shut-off PSI			307	298	290	281	264	246	229	212	195	177	160	143	125	108	91	73	56	39

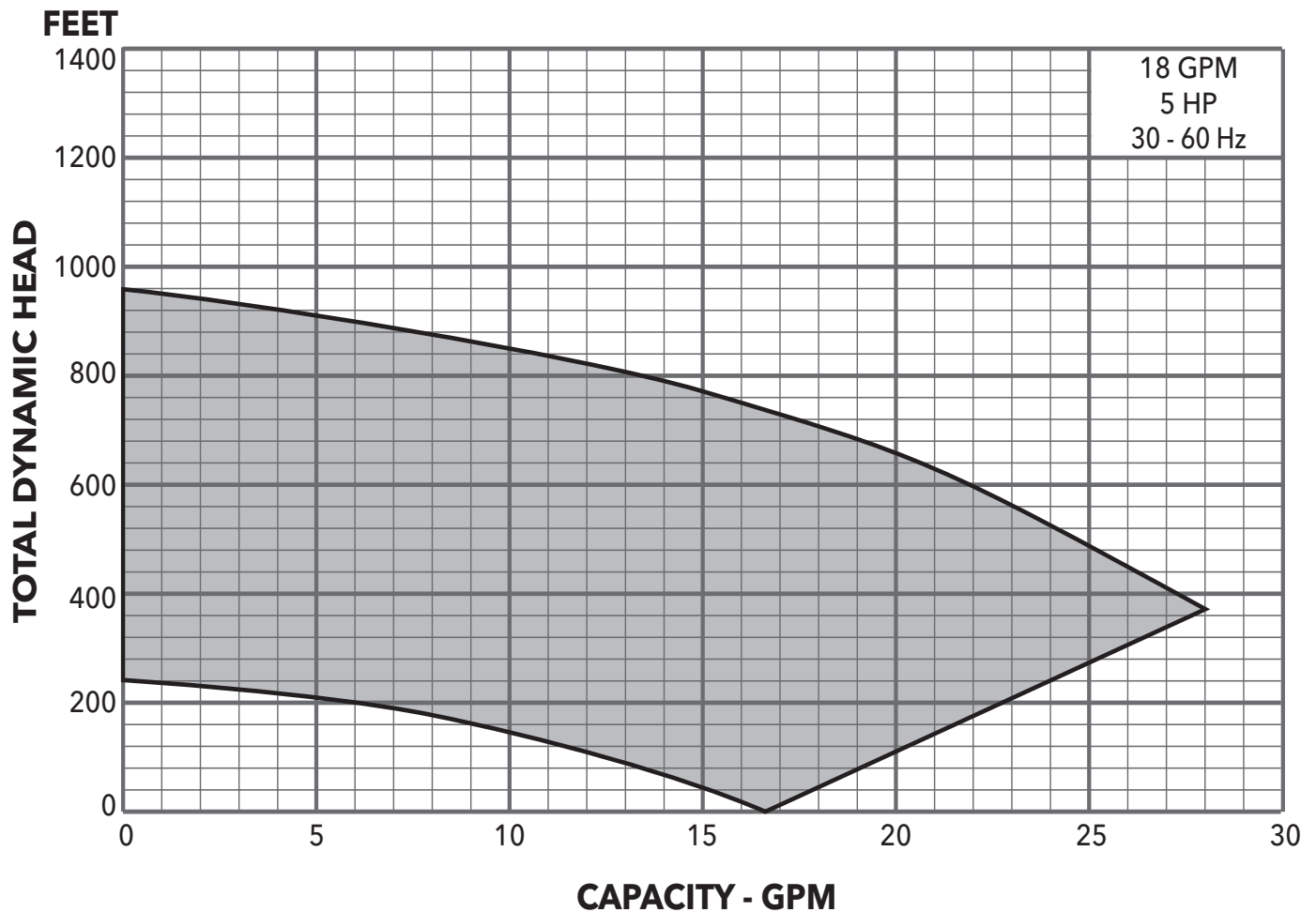

MODEL 25GS20 30-60 Hz with 2 HP Motor and 3AS20

SELECTION CHART

Pump Model	HP	PSI	Depth to Water in Feet/Ratings in GPM (Gallons Per Minute)														
			20	40	60	80	100	120	140	160	180	200	220	240	260	280	300
25GS20	2	0						33.0	31.8	30.4	29.0	27.4	25.7	22.6	21.5	19.3	15.4
		50		30.5	29.4	28.0	26.0	24.1	22.1	20.0	17.2	13.2					
		60	30.4	29.0	27.4	25.7	22.6	21.5	19.3	15.4	12.2						
Shut-off PSI			139	130	121	113	104	95	87	78	69	61	52	43	35	26	17

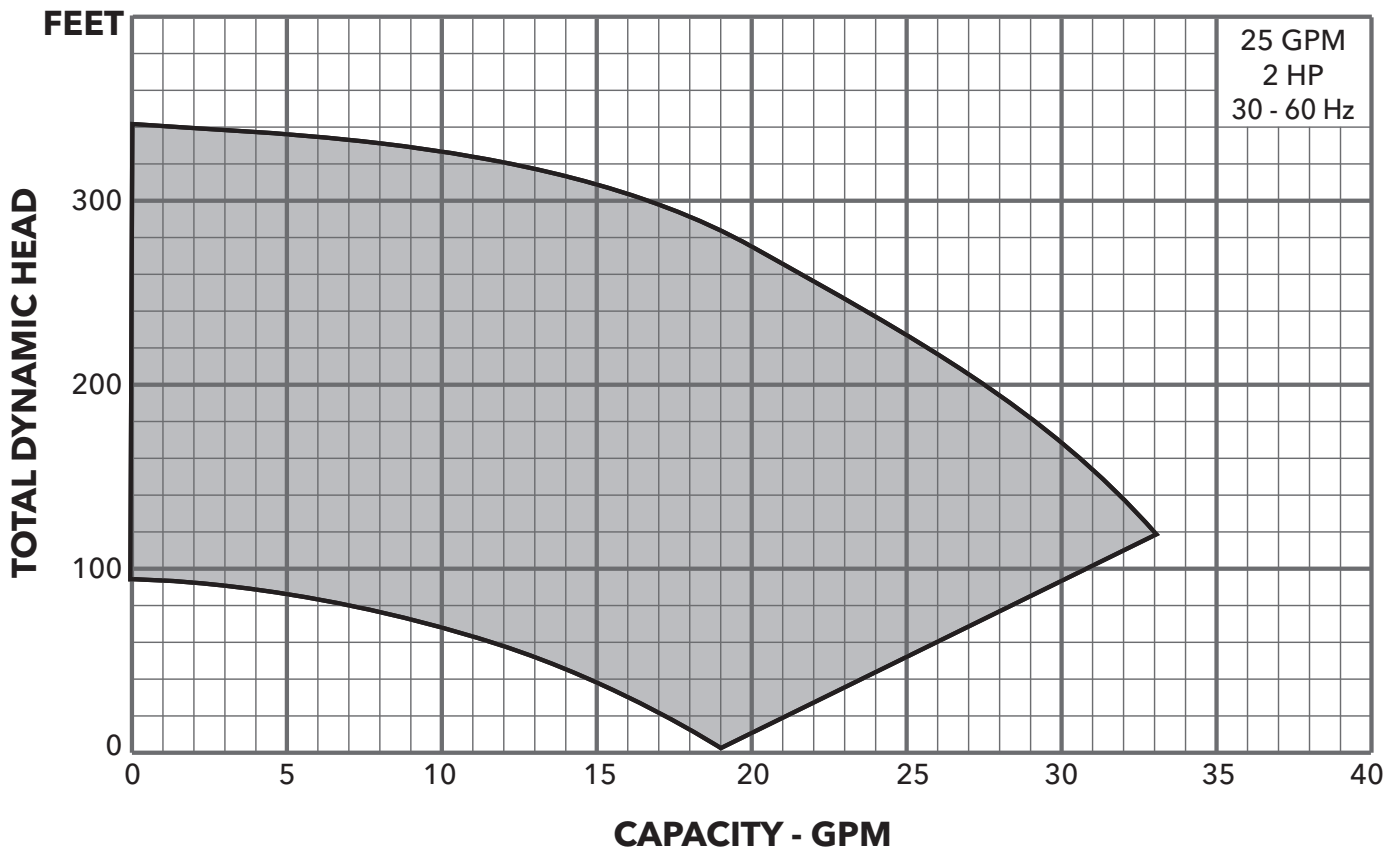

MODEL 25GS30 30-60 Hz with 3 HP Motor and 3AS30

SELECTION CHART

Pump Model	HP	PSI	Depth to Water in Feet/Ratings in GPM (Gallons Per Minute)																			
			20	40	60	80	100	120	140	160	180	200	220	240	260	280	300	340	380	420		
25GS30	3	0									33.0	32.2	31.5	30.5	29.6	28.3	27.1	25.8	22.6	19.0	14.0	
		50			32.3	31.6	30.8	29.8	28.5	27.3	26.0	24.5	23.0	21.2	19.5	17.4	11.5					
		60	33.0	32.2	31.5	30.5	29.6	28.3	27.1	25.8	24.1	22.6	20.9	19.0	16.9	14.0	10.0					
Shut-off PSI			191	183	174	165	157	148	139	131	122	113	105	96	87	79	70	53	35	18		

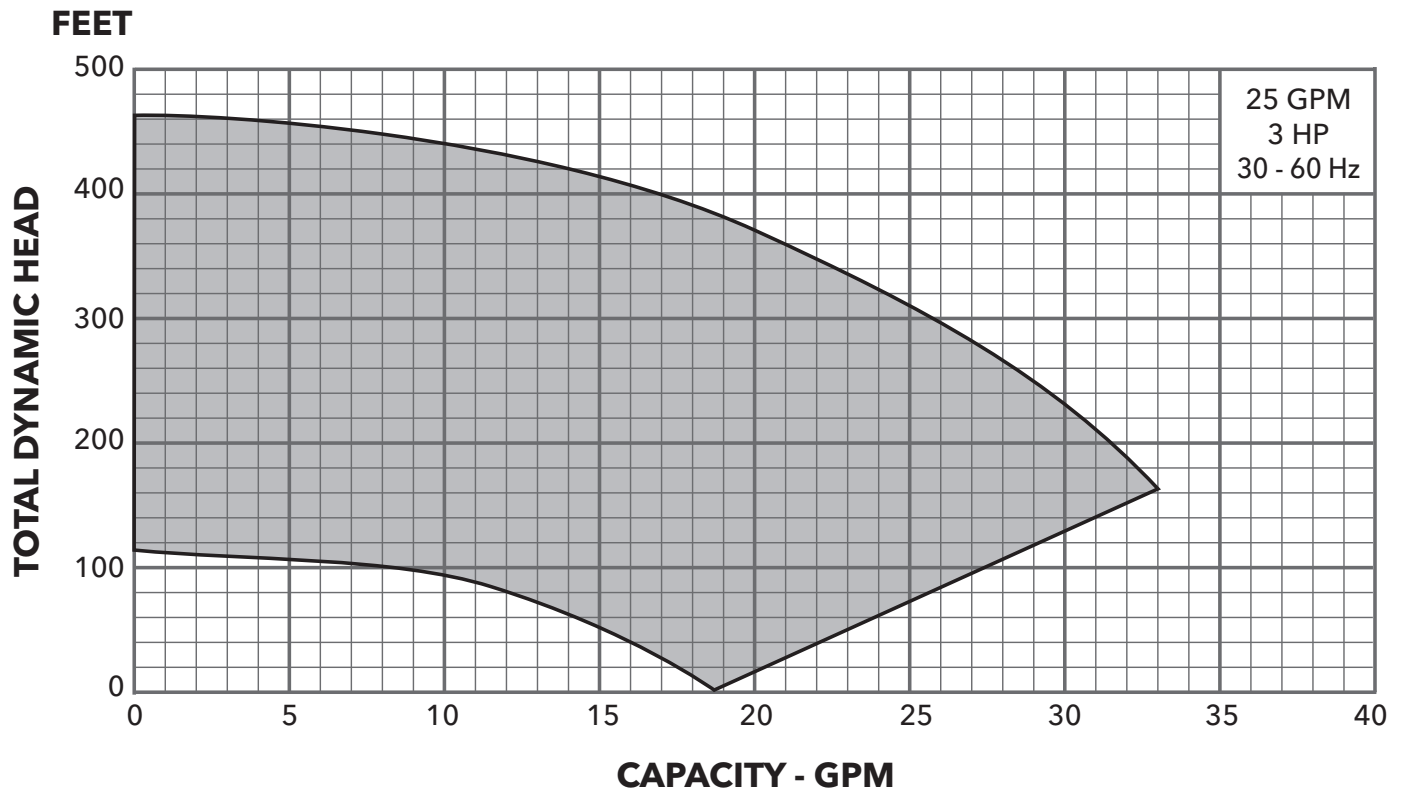

MODEL 25GS50 30-60 Hz with 5 HP Motor and 3AS50

SELECTION CHART

Pump Model	HP	PSI	Depth to Water in Feet/Ratings in GPM (Gallons Per Minute)																			
			140	160	180	200	220	240	260	280	300	340	380	420	460	500	540	580	620	660	700	740
25GS50	5	0								33.0	32.5	31.5	30.2	29.0	27.6	26.0	24.2	22.4	20.5	18.3	15.8	12.0
		50			32.6	32.1	31.6	31.0	30.3	29.9	29.2	27.8	26.3	24.5	22.6	21.8	18.7	16.0	12.7			
		60	33.0	32.5	32.0	31.5	30.8	30.2	29.8	29.0	28.3	26.9	25.1	23.3	21.5	19.5	17.0	14.0	9.5			
Shut-off PSI			286	277	268	260	251	242	234	225	216	199	182	165	147	130	113	95	78	61	43	26

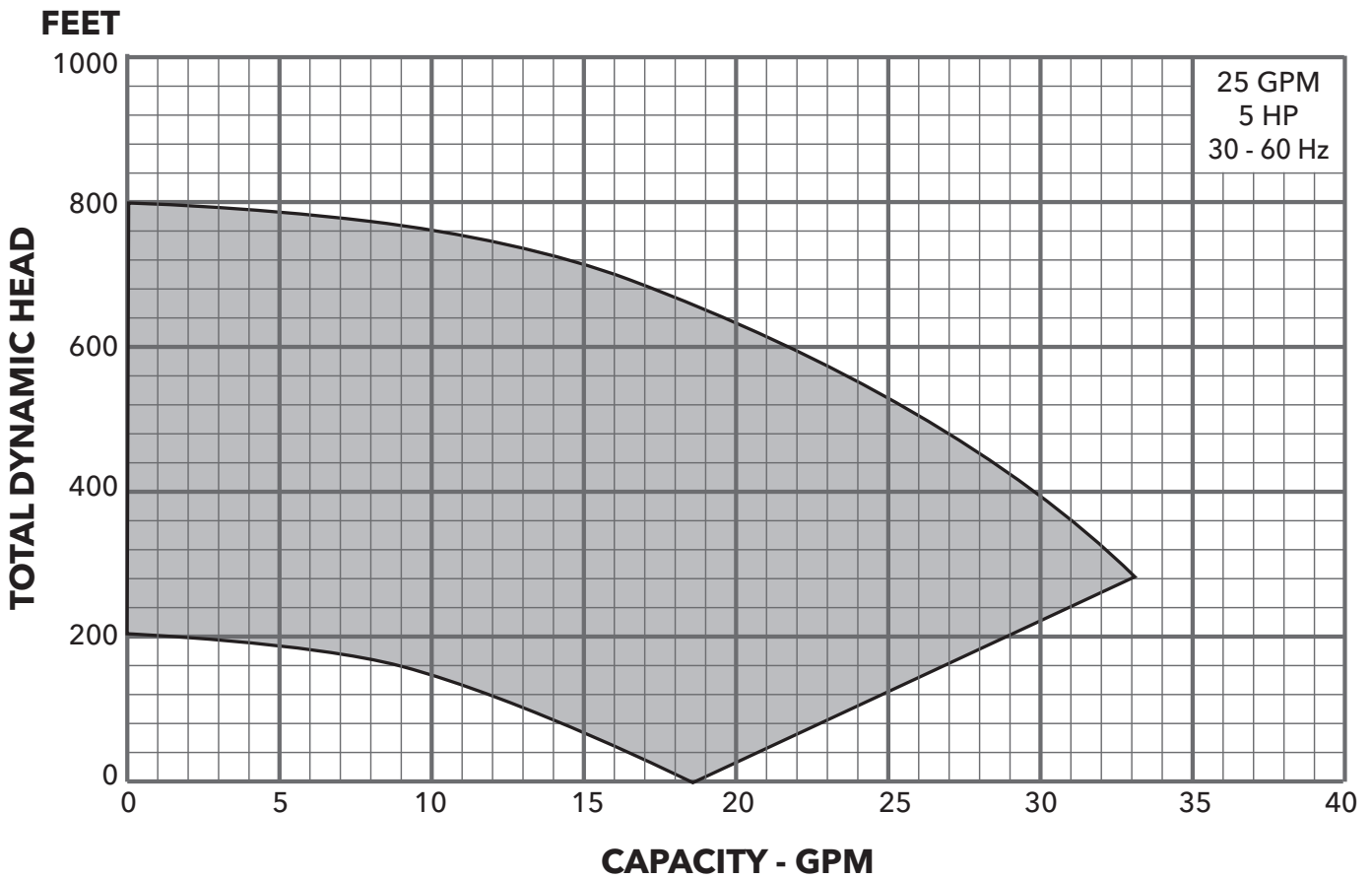

MODEL 35GS30 30-60 Hz with 3 HP Motor and 3AS30

SELECTION CHART

Pump Model	HP	PSI	Depth to Water in Feet/Ratings in GPM (Gallons Per Minute)																				
			20	40	60	80	100	120	140	160	180	200	220	240	260	280	300	320	340	360	380	400	
35GS30	3	0				50	48	47	45	44	42	41	39	38	36	34	31	28	25	21	16	10	
		20		49	48	46	45	43	42	40	39	37	35	33	30	27	24	19	14				
		30	49	47	46	45	43	42	40	39	37	35	33	30	27	23	18	13					
		40	47	46	44	43	41	40	38	37	35	32	30	26	22	18	12						
		50	46	44	43	41	40	38	36	34	32	29	26	22	17	11							
		60	44	42	41	39	38	36	34	31	29	25	21	16	10								
Shut-off PSI			176	168	159	150	142	133	124	116	107	98	90	81	72	64	55	46	38	29	20	12	

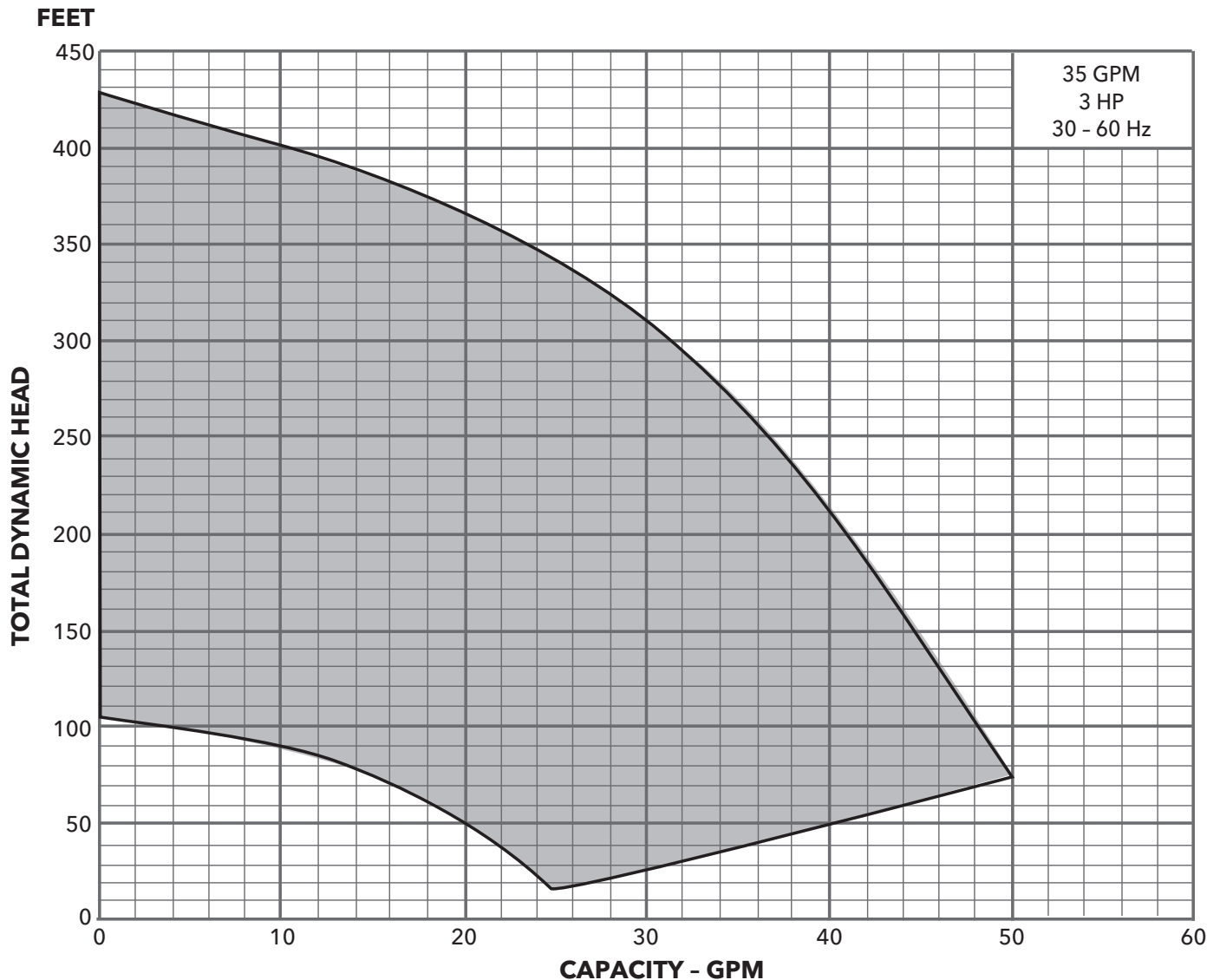

MODEL 35GS50 30-60 Hz with 5 HP Motor and 3AS50

SELECTION CHART

Pump Model	HP	PSI	Depth to Water in Feet/Ratings in GPM (Gallons per Minute)																											
			50	100	150	200	250	300	350	400	450	500	550	600	650	700	750	800	850	900	950	1000	1050	1100	1150	1200	1250	1300	1350	
35GS50	5	0			50	48	46	43	41	38	35	31	26	19	11															
		20		50	48	46	44	41	38	35	31	26	20	12																
		30		49	47	45	42	40	37	33	29	24	16																	
		40	50	48	46	44	41	38	35	31	27	20	12																	
		50	49	47	45	43	40	37	34	29	24	17																		
			48	46	44	41	39	35	32	27	21	13																		
Shut-off PSI			280	259	237	215	194	172	150	129	107	85	64	42																

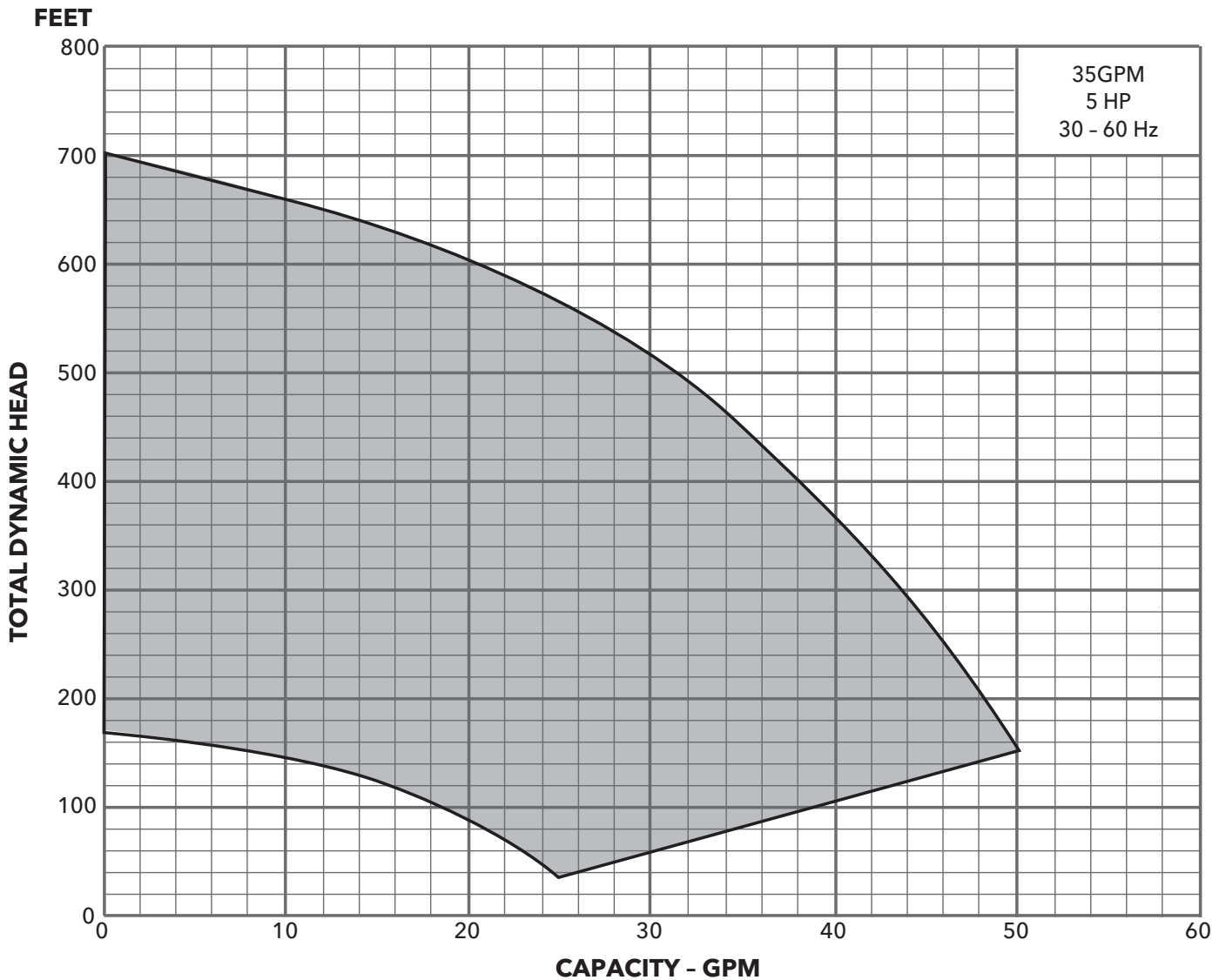

WIRE SIZING - MAXIMUM CABLE LENGTHS IN FEET TO LIMIT VOLTAGE DROP TO 5% FOR 230 V SYSTEMS ^⑤

Service Entrance to Controller

Controller Input	Motor HP	Copper Wire Size 75°C Insulation Exposed to a Maximum of 50°C (122°F) Ambient Temperature ^⑥															
		14	12	10	8	6	4	2	1/0	2/0	3/0	4/0	250	300	350	400	500
230V 1 PH	¾	279	445	706	1020	1608	2552	4019	6383	8055							
	1	226	360	571	824	1300	2064	3250	5161	6513	8201						
	1½	*	286	455	657	1036	1644	2589	4111	5188	6533	8236	9710				
	2	*	*	331	478	754	1197	1886	2995	3779	4759	5999	7073	8455	9852		
	3	*	*	246	355	561	890	1401	2225	2808	3536	4458	5256	6283	7321	8343	
	5	*	*	*	218	343	545	858	1363	1720	2165	2730	3219	3847	4483	5109	6348

Controller to Motor

Controller Output	Motor HP	Copper Wire Size 75°C Insulation Exposed to a Maximum of 50°C (122°F) Ambient Temperature ^⑥												
		14	12	10	8	6	4	2	1/0	2/0	3/0	4/0	250	300
230V 3 PH	¾	690	1100	1748	2523	3978	6316	9945						
	1	558	890	1413	2040	3216	5106	8041						
	1½	445	709	1126	1625	2562	4068	6406						
	2	324	516	820	1184	1866	2963	4666	7410	9351				
	3	241	384	609	880	1387	2202	3467	5506	6949	8750			
	5	*	235	373	539	849	1348	2123	3372	4255	5358	6755	7964	9520

^⑤ Reduce lengths by 13% for 200 V systems. ^⑥ Lengths in bold require 90°C wire. Shading indicates 40° C maximum ambient.

* Wire does not meet the N.E.C. ampacity requirement.

The lengths in each of the Wire Sizing tables represent 100% of the allowable voltage drop when motor is running at full load. When sizing wire, the voltage drop of each wire segment must be included. The total must not exceed 100% of the allowable drop. Take for example a 1.5 HP motor with a distance from Service Entrance to Controller of 100' and 500' between the Controller and Motor.

- Service Entrance to Controller = 100' of 10 AWG (100/455) = 22% (455' is from the S.E. to Controller chart)
 - Controller to Motor = 500' of 12 AWG (500/709) = 71% (709' is from the Controller to Motor chart)
- Total Drop (must be ≤ 100%) 93%

If the distance from the Controller to Motor was 600' (600/709) = 85% + 22% = 107%, we would need to use #10 wire for that segment, ex. 600/1126 = 53% + 22% (for 100' of #10) = 75% which is acceptable. It is also acceptable to use different wire sizes for the Buried and Well sections of wire.

Controller, Breaker, Generator Sizing

Motor HP	Voltage ^①	Controller Model ^②				Circuit Breaker ^③	Generator ^④ (VA)
		1AS15	3AS20	3AS30	3AS50		
½	230					15	2200
	200						
¾	230					15	2900
	200						
1	230					15	3500
	200						
1½	230					20	4400
	200						
2	230					30	6100
	200						
3	230					30	8100
	200						
5	230					50	13300
	200						

^① Supply voltage must be 196 VAC - 265 VAC.

^② Shaded areas indicate which controller models can be used with which motors. Lighter shading indicates combinations where controller will limit peak performance to 85% of catalog value for pump/motor.

^③ Circuit Breaker or Dual Element Time Delay Fuse Size (Amps) protecting branch circuit supplying controller.

^④ Minimum size of single phase 240 V generator required.

THREE PHASE, 4", MOTOR DATA

Electrical Data, 60 Hertz, 3450 RPM, 4" Motors

GWT #	Red Jacket #	HP	kW	Volts	SF	Full Load		Service Factor		Locked Rotor Amps	Line - Line Resistance
						Amps	Watts	Amps	Watts		
M07430	75C323	0.75	0.55	200	1.5	3.8	812	4.5	1140	32	2.6-3.0
M10430	100C323	1	0.75		1.4	4.6	1150	5.5	1500	29	3.4-3.9
M15430	150C323	1.5	1.1		1.3	6.3	1560	7.2	1950	40	1.9-2.5
M20430	200C323	2	1.5		1.25	7.5	2015	8.8	2490	51	1.4-2.0
M30430	300C323	3	2.2		1.15	10.9	2890	12.0	3290	71	0.9-1.3
M50430	500C323	5	3.7		1.15	18.3	4850	20.2	5515	113	0.4-0.8
M07432	75C313	0.75	0.55	230	1.5	3.3	850	3.9	1185	27	3.3 - 4.3
M10432	100C313	1	0.75		1.4	4.0	1090	4.7	1450	26.1	4.1-5.1
M15432	150C313	1.5	1.1		1.3	5.2	1490	6.1	1930	32.4	2.8-3.4
M20432	200C313	2	1.5		1.25	6.5	1990	7.6	2450	44	1.8-2.4
M30432	300C313	3	2.2		1.15	9.2	2880	10.1	3280	58.9	1.3-1.7
M50432	500C313	5	3.7		1.15	15.7	4925	17.5	5650	93	.85-1.25

Diaphragm Tank Sizing and Pre-Set Pressure Recommendations:

Diaphragm type (captive air) tanks are required on these systems.

Table 1: Tank Sizing Selection

Maximum Pump GPM	Recommended Tanks		
	Total Volume	Order No.	or Order No.
10	2	V6P	TP6P
23	4.5	V15P	TP15P
41	8.2	V25P	TP25P
70	13.9	V45	TP45
100	19.9	V60	TP60

Use Total Tank Volume, not drawdown volume, to select the proper tank size. The total tank volume should be approximately 20% of the pump's maximum flow. For example, when using a 10 gpm pump the system requires a minimum 2 gallon (total volume) tank.

The tank sizing recommendations are field proven to prevent objectionable pressure drops on start-up and provide smooth operation for the majority of variable speed pump systems.

Set the tank pressure, while tank is empty of water, to 20 psi below the desired system pressure setting. Ex. for a 50 psi system pressure, charge the tank to 30 psi.

Service Factor Amps All Motors

HP	230 Volt									200 Volt	
	1Ø 2-Wire			1Ø 3-Wire			3Ø			3Ø	
	GWT ¹	Franklin	Grundfos	GWT	Franklin	Grundfos	GWT	Franklin	Grundfos	GWT	Franklin
½	4.7/4.7	6	6	6.3	6	6	N/A	N/A	N/A	N/A	N/A
¾	6.4/6.2	8	8.4	8.3	8	8.4	3.9	3.8	N/A	4.5	4.4
1	9.1/8.1	9.8	9.8	9.7	9.8	9.8	4.7	4.7	N/A	5.5	5.4
1½	11.0/10.4	13.1	13.1	11.1	11.5	11.6	6.1	5.9	7.3	7.2	6.8
2	N/A	N/A	N/A	12.2	13.2 ²	13.2 ²	7.6	8.1	8.7	8.8	9.3
3	N/A	N/A	N/A	N/A	N/A	N/A	10.1	10.9	12.2	12	12.5
5	N/A	N/A	N/A	N/A	N/A	N/A	17.5	17.8	19.8	20.2	20.5

1. Goolds Water Technology 2-Wire motors have Generation 1 and Generation 2 amp ratings, see motor nameplate or motor data sticker that was supplied with motor.

2. Amps are higher than controller overload range - use of these motors will current limit and provide reduced performance.

3AS_ _ UIB CONTROLLERS

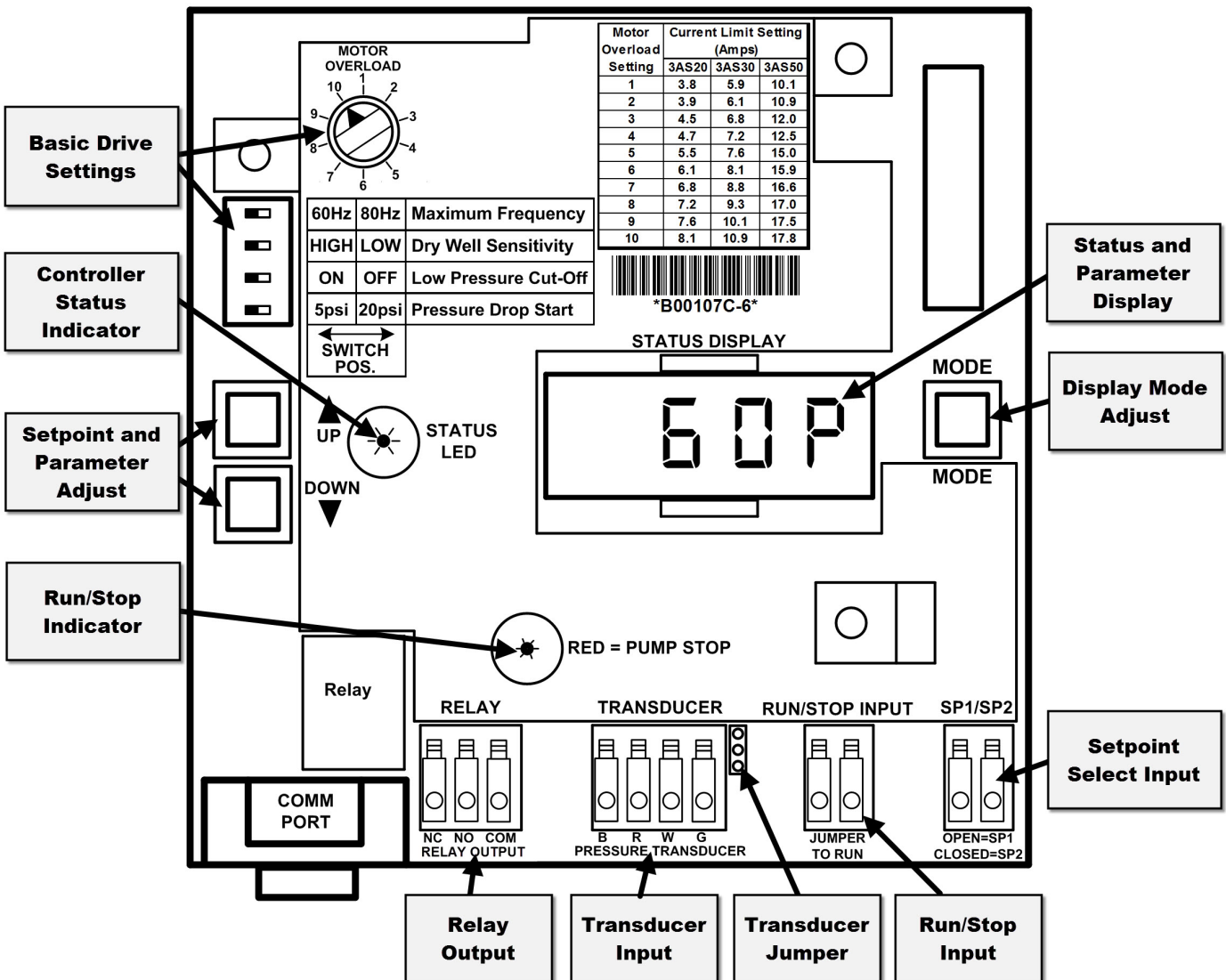

PRESSURE RANGES FOR ALL AVAILABLE TRANSDUCERS

Transducer	1AS15 / 3AS20		3AS30		3AS50	
	Minimum PSI	Maximum PSI	Minimum PSI	Maximum PSI	Minimum PSI	Maximum PSI
100 PSI ①	20	85	20	85	10	50
200 PSI ②	40	170	40	170	20	100
300 PSI	60	255	60	255	30	150

① Standard on 1AS15/3AS20, 3AS30

② Standard on 3AS50

Warning! Exploding tank can injure or kill, some combinations of Transducer and Controller allow system pressure adjustment to exceed the maximum working pressure of the tank and piping.

Ensure system pressure is set below the maximum working pressure of the tank and system piping.

Protect tank and piping against overpressure, install a properly sized pressure relief valve (PRV) able to pass full pump flow at the maximum working pressure of the tank. In finished basements or where PRV blow-off can cause property damage, pipe the PRV to a suitable drain.

DIMENSIONS (inches) - ALL MODELS

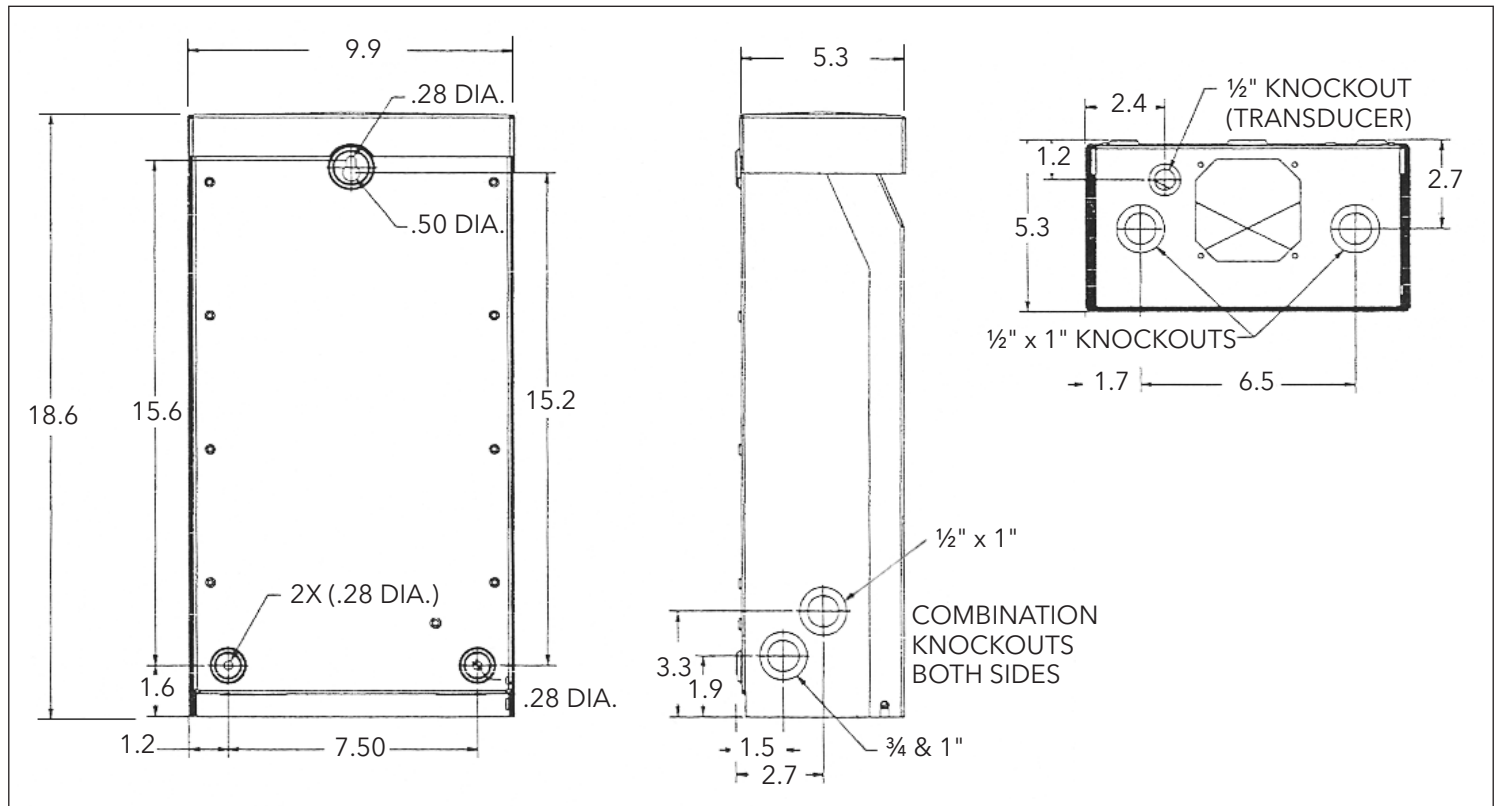

xylem
Let's Solve Water

Xylem Inc.
2881 East Bayard Street Ext., Suite A
Seneca Falls, NY 13148
Phone: (866) 325-4210
Fax: (888) 322-5877
www.xylem.com/goulds

Xylem and Aquavar are registered trademarks of Xylem Inc. or one of its subsidiaries. Goulds is a registered trademark of ITT Manufacturing Enterprises LLC and is used under license. All other trademarks or registered trademarks are property of their respective owners.

© 2022 Xylem Inc. BGPROPAK60 R5 December 2022