

1960-DST-▲

Submitted Model No.: _____

Specific Features: _____

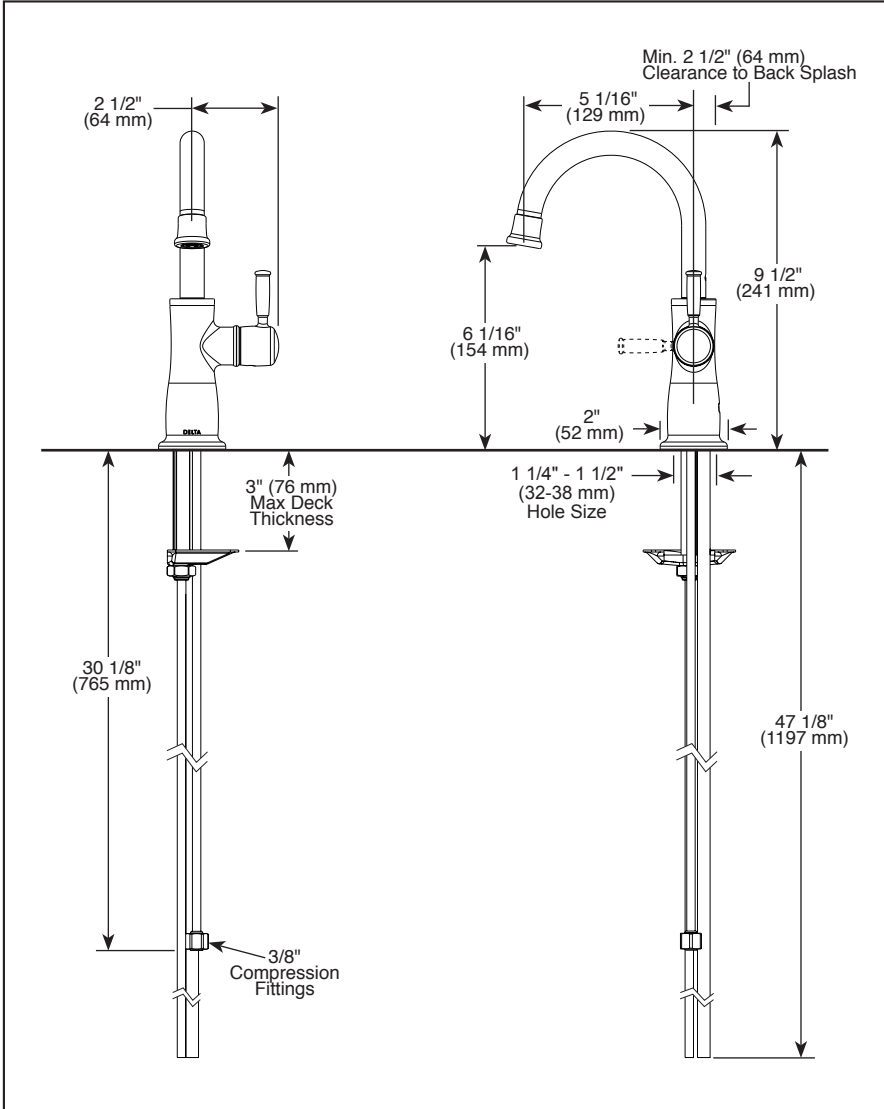

▲ Designate proper finish suffix



see what Delta can do™

COLD WATER DISPENSERS

- Single Handle Deck Mount
- 1 Hole Sink Applications
- Integrated Supply Tubes
- Air Gap Included

FEATURES:

- Diamond Seal® Technology

STANDARD SPECIFICATIONS:

- Laminar water stream with max flow rate 1.5 gpm @ 60 psi, 5.7 L/min @ 414 kPa
- Works with RO systems, filtered water systems, or as a cold water tap
- Spout swings 360°
- Single lever handle design
- Air gap included with 1/4" tube for RO system and 3/8" tube for drain
- Mounting wrench to assist in tightening mounting nut securely
- Integrated supply tube with 3/8" compression fitting

WARRANTY

- Parts and Finish - Lifetime limited warranty; or for commercial purchasers, 10 years for multi-family residential (apartments and condominiums) and 5 years for all other commercial uses, in each case from the date of purchase.
- Electronic Parts and Batteries (if applicable) - 5 years from the date of purchase; or for commercial purchasers, 1 year from the date of purchase. No warranty is provided on batteries.

COMPLIES WITH:

- ASME A112.18.1 / CSA B125.1
- ASME A112.18.6
- ♿ Indicates compliance to ICC/ANSI A117.1 - Valve control only
- Verified compliant with .25% weighted average Pb content regulations.

Delta reserves the right (1) to make changes in specifications and materials, and (2) to change or discontinue models, both without notice or obligation. Dimensions are for reference only. See current full-line price book or www.deltafaucet.com for finish options and product availability.

DSP-K-1960-DST Rev. A

Delta Faucet Company

55 E. 111th Street, Indianapolis, IN 46280
 350 South Edgeware Road, St. Thomas, ON N5P 4L1
 © 2020 Delta Faucet Company