

Features

- Vitreous china.
- Comfort Height® Elongated bowl.
- AquaPiston® flushing system.
- Includes left-hand polished chrome trip lever.
- 1.28 gpf (4.8 lpf).
- 2-1/8" (54 mm) fully glazed trapway.
- 12" (305 mm) rough-in.
- Less seat and supply.
- 11-3/4" (298 mm) x 9-1/2" (241 mm) water area.
- 30-3/8" (772 mm) x 18-7/8" (479 mm) x 31-1/16" (789 mm).
- Floor mount / Floor outlet.
- Insuliner® tank liner included.

Recommended Accessories

- K-4636 Cachet® Quiet-Close™ Elongated Toilet Seat
- K-5588 Purefresh® Elongated Toilet Seat
- K-4108 C3®-230 Elongated Cleansing Toilet Seat
- K-5420 Low-Profile Bolt Caps

Components

Product includes:

- K-4380 Toilet Bowl
- K-4434-U Toilet Tank

Additional included component/s: Tank cover, Trip lever, Bolt cap accessory pack, and Tank accessory pack.



ADA

CSA B651

OBC

Codes/Standards







ASME A112.19.2/CSA B45.1
DOE - Energy Policy Act 1992
EPA WaterSense®
California Energy Commission (CEC)
ADA
ICC/ANSI A117.1
CSA B651
OBC

KOHLER® One-Year Limited Warranty

See website for detailed warranty information.

Available Color/Finishes

Color tiles intended for reference only.

Color	Code	Description
	0	White
	96	Biscuit
	47	Almond
	NY	Dune
	95	Ice™ Grey
	G9	Sandbar
	7	Black Black™

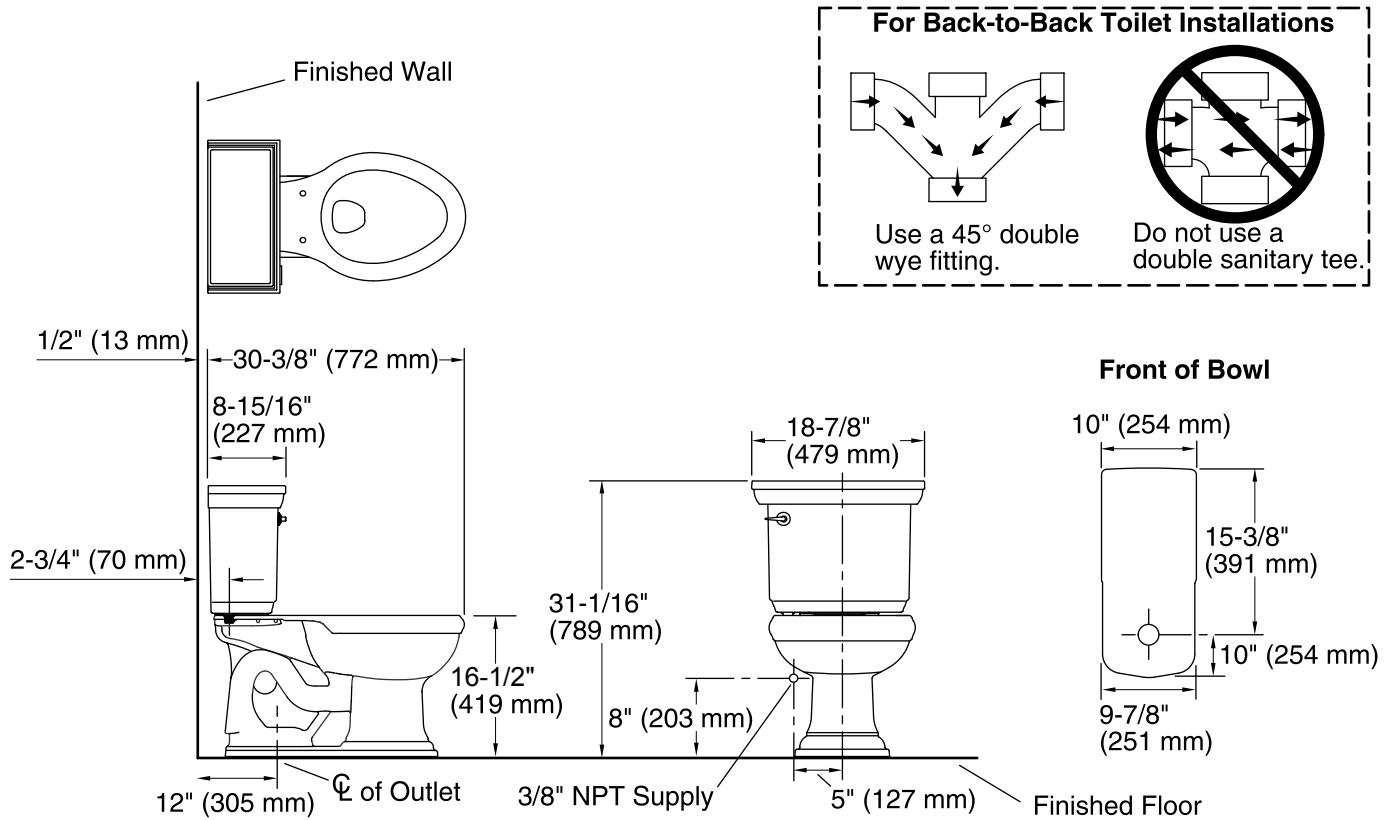

Technical Information

All product dimensions are nominal.

Toilet type:	Two-piece, Floor-mount
Waste Outlet:	Floor
Bowl shape:	Elongated front
Flush type:	AquaPiston
Trap passageway:	2-1/8" (54 mm)
Water Consumption	
Full:	1.28 gpf (4.8 lpf)
Water surface size:	11-3/4" x 9-1/2" (298 mm x 241 mm)
Rim to water surface:	6-1/8" (156 mm)
Rough-in:	12" (305 mm)
Seat-mounting holes:	5-1/2" (140 mm)

Notes

Install this product according to the installation instructions.

For back-to-back toilet installations: Use only a 45° double wye fitting.

ADA, OBC, CSA B651 compliant when installed to the specific requirements of these regulations.

Plumbing Codes require elongated toilets and elongated, open-front toilet seats in public bathrooms.

Accessibility standards require controls to be located on the open side of the toilet.