

Features

- Includes faceplate with handle
- A single handle controls both on/off activation and temperature setting
- Integrated push-button diverter
- Complements Artifacts faucets and accessories

Material

- Premium material construction with metal handle ensures reliability and durability
- KOHLER finishes resist corrosion and tarnishing

Installation

- Trim only; requires valve to complete installation (sold separately)

Recommended Products/Accessories

K-23723 Faucet cleaner

Optional Products/Accessories

1204798 Deep Rough-in Kit for Rite-Temp Valve



ADA

CSA B651

OBC

Codes/Standards

ASME A112.18.1/CSA B125.1

ADA

ICC/ANSI A117.1

CSA B651





OBC

KOHLER® Faucet Lifetime Limited Warranty

See website for detailed warranty information.

Available Colors/Finishes

Color tiles intended for reference only.

| Color | Code | Description |
|---|------|--------------------------|
|  | CP | Polished Chrome |
|  | SN | Vibrant™ Polished Nickel |
|  | BN | Vibrant™ Brushed Nickel |
|  | BV | Vibrant™ Brushed Bronze |
|  | 2BZ | Oil-Rubbed Bronze |

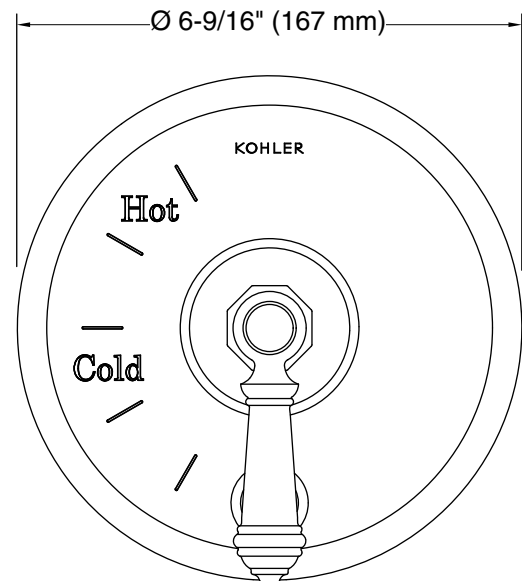
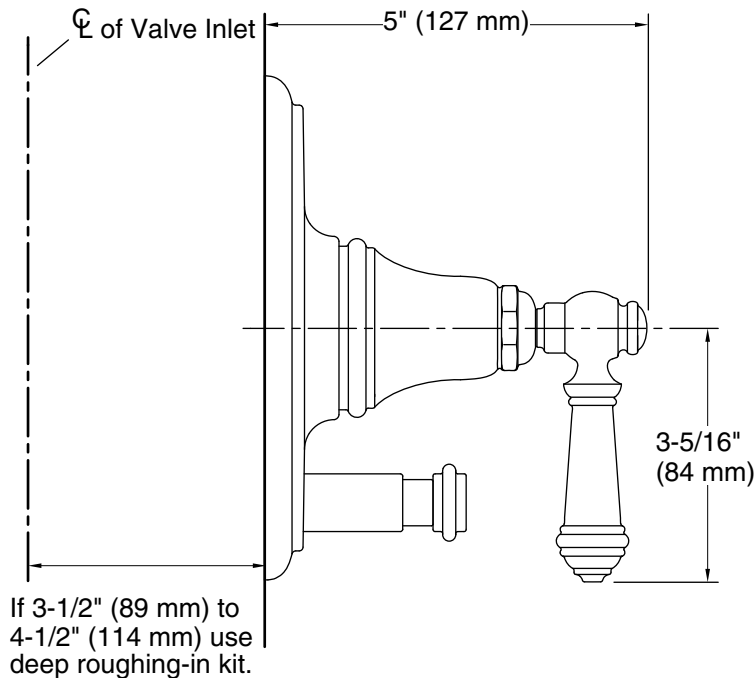

Technical Information

All product dimensions are nominal.

Notes

Install this product according to the installation instructions.

Avoid cross-flow conditions. Do not install shut-off device on either valve outlet.

Install straight pipe or tube drop of 7" (178 mm) to 18" (457 mm) with single elbow between the valve and wall-mount spout.

ADA, OBC, CSA B651 compliant when installed to the specific requirements of these regulations.