

Features

- Metal construction
- Includes installation hardware
- Complements the Margaux Suite

Codes/Standards Applicable











Specified model meets or exceeds the following:

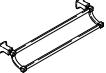

- None applicable

Colors/Finishes

- CP: Polished Chrome
- Other: Refer to Price Book for additional colors/finishes

Specified Model

Model/Description	
K-16250 18" (457 mm) towel bar <input type="checkbox"/> CP <input type="checkbox"/> Other_____	
K-16251 24" (610 mm) towel bar <input type="checkbox"/> CP <input type="checkbox"/> Other_____	
K-16252 30" (762 mm) towel bar <input type="checkbox"/> CP <input type="checkbox"/> Other_____	
K-16253 Double towel bar <input type="checkbox"/> CP <input type="checkbox"/> Other_____	
K-16254 Towel ring <input type="checkbox"/> CP <input type="checkbox"/> Other_____	
K-16255 Vertical toilet tissue holder <input type="checkbox"/> CP <input type="checkbox"/> Other_____	
K-16256 Robe hook <input type="checkbox"/> CP <input type="checkbox"/> Other_____	
K-16257 Valet <input type="checkbox"/> CP <input type="checkbox"/> Other_____	
K-16258 Glass shelf <input type="checkbox"/> CP <input type="checkbox"/> Other_____	
K-16259 Soap dish <input type="checkbox"/> CP <input type="checkbox"/> Other_____	
K-16260 Tumbler <input type="checkbox"/> CP <input type="checkbox"/> Other_____	

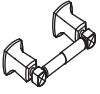
Model/Description	
K-16262 Knob cabinet hardware <input type="checkbox"/> CP <input type="checkbox"/> Other_____	
K-16263 Pull cabinet hardware <input type="checkbox"/> CP <input type="checkbox"/> Other_____	
K-16265 Horizontal tissue holder <input type="checkbox"/> CP <input type="checkbox"/> Other_____	

Product Specification

The accessories shall be of metal construction. Product shall include installation hardware. Product shall complement the Margaux Suite. Accessories shall be Kohler Model K-____-____.

MARGAUX™

Installation Notes



CAUTION: Risk of personal injury. Do not install these products in any area where they are likely to be used inadvertently as a grab bar or support bar. These products are not designed or intended for use as a grab bar or support bar.

Install this product according to the installation guide.

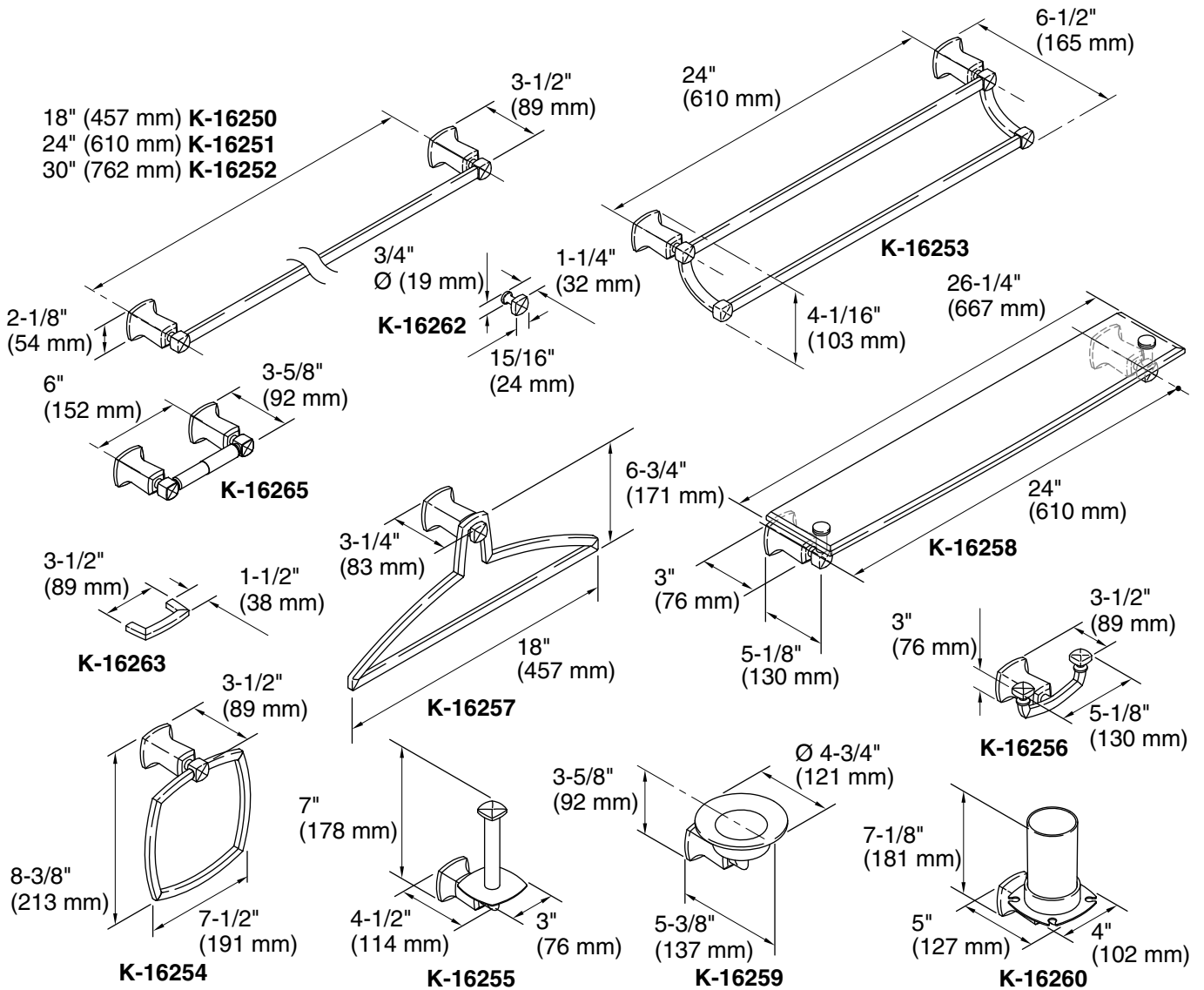

Product Diagram