

Features

- Solid brass construction for durability and reliability.
- 1-1/4" connection.
- Reliable with non-removable metal stopper.
- For use in overflow applications.



Codes/Standards







ASME A112.18.2/CSA B125.2

Kohler One-Year Limited Warranty

See website for detailed warranty information.

Available Color/Finishes

Color tiles intended for reference only.

Color	Code	Description
	CP	Polished Chrome
	SN	Vibrant® Polished Nickel
	BGD	Vibrant® Moderne Brushed Gold
	BN	Vibrant® Brushed Nickel
	BV	Vibrant® Brushed Bronze
	2BZ	Oil-Rubbed Bronze
	TT	Titanium

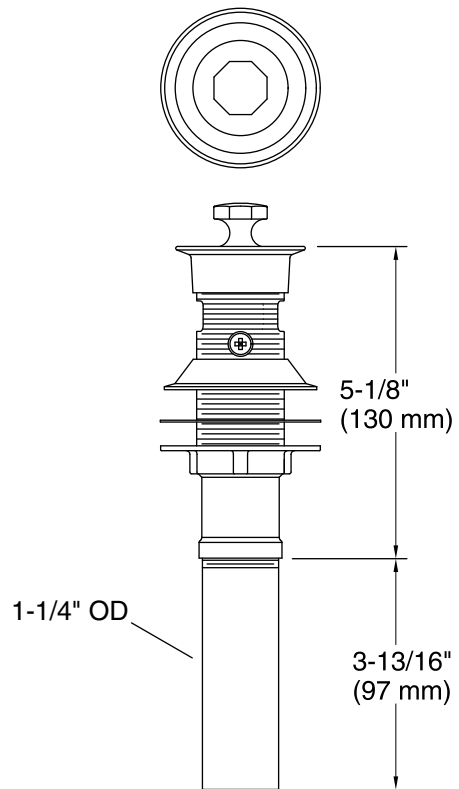

Technical Information

All product dimensions are nominal.

Notes

Install this product according to the installation guide.